



**SOUTH DAKOTA STATE  
UNIVERSITY EXTENSION**



# 2023 South Dakota 4-H Horse Project Show Guide

Kaycee Jones | SDSU Extension 4-H Youth Program Advisor, Haakon and Jackson Counties  
and South Dakota State 4-H Horse Committee Chair

Mary Kay Sell | SDSU Extension 4-H Youth Program Advisor, Bennett County and  
South Dakota 4-H Horse Committee

Lesley Rygaard | SDSU Extension 4-H Youth Program Advisor, Bon Homme and Charles Mix  
Counties and South Dakota 4-H Horse Committee

## Table of Contents

|   |          |   |           |
|---|----------|---|-----------|
| <b>Classes</b> . . . . .  | <b>1</b> | <b>Western Horsemanship</b> . . . . .               | <b>10</b> |
| <b>General 4-H Rules</b> . . . . .                              | <b>2</b> | Description . . . . .                               | 10        |
| Changes for 2023 . . . . .                                      | 2        | Class Routine . . . . .                             | 10        |
| Insurance . . . . .   | 2        | Tack and Attire . . . . .                           | 10        |
| Liability . . . . .   | 2        | Seat and Hands . . . . .                            | 10        |
| South Dakota 4-H Code of Animal Show Ring                       |          | Hand Set . . . . .                                  | 10        |
| Ethics . . . . .  | 2        | Basic Riding Position . . . . .                     | 11        |
| Local Determinations . . . . .                                  | 3        | Position in Motion . . . . .                        | 11        |
| Protest Procedure . . . . .                                     | 3        | Scoring and Penalties . . . . .                     | 11        |
| Age Divisions for South Dakota 4-H Youth . . . . .              | 3        | <b>Ranch Riding</b> . . . . .                       | <b>12</b> |
| <b>South Dakota 4-H Horse Project</b> . . . . .                 | <b>3</b> | Description . . . . .                               | 12        |
| Purpose and Objectives of the 4-H Horse                         |          | Class Routine . . . . .                             | 12        |
| Program . . . . .   | 3        | Tack and Attire . . . . .                           | 12        |
| Youth Horse Literacy . . . . .                                  | 3        | Scoring . . . . .                                   | 13        |
| Horse Ownership . . . . .                                       | 3        | Ranch Riding Terminology . . . . .                  | 13        |
| <b>4-H Horse Show Rules</b> . . . . .                           | <b>4</b> | <b>Reining</b> . . . . .                            | <b>14</b> |
| General Rules . . . . .   | 4        | Description . . . . .                               | 14        |
| Horse Show Judges . . . . .                                     | 5        | Class Routine . . . . .                             | 14        |
| State Horse Show . . . . .                                      | 5        | Tack and Attire . . . . .                           | 14        |
| Pony Measuring . . . . .  | 5        | Scoring . . . . .                                   | 14        |
| Exhibitor Attire . . . . .                                      | 5        | Reining Terminology . . . . .                       | 15        |
| Western Attire . . . . .  | 5        | Pattern Clarification . . . . .                     | 15        |
| English Attire . . . . .  | 5        | <b>Trail</b> . . . . .                              | <b>15</b> |
| Driving Attire . . . . .  | 5        | Description . . . . .                               | 15        |
| Youth in Action Attire . . . . .                                | 6        | Class Routine . . . . .                             | 16        |
| Tack . . . . .  | 6        | Tack and Attire . . . . .                           | 16        |
| Curb Bits . . . . .   | 6        | Mandatory Obstacles . . . . .                       | 16        |
| Snaffle Bits and Bosals . . . . .                               | 6        | Optional Obstacles . . . . .                        | 16        |
| Curb Chains and Straps . . . . .                                | 6        | Scoring . . . . .                                   | 16        |
| Reins . . . . .   | 6        | <b>English Performance and Equitation</b> . . . . . | <b>18</b> |
| Riding Restraints . . . . .                                     | 6        | English Tack and Saddles . . . . .                  | 18        |
| Leg Wear . . . . .  | 6        | <b>Hunt Seat Equitation</b> . . . . .               | <b>18</b> |
| Awards System . . . . .   | 6        | Description . . . . .                               | 18        |
| <b>Pattern Classes for Equitation and Performance</b> . . . . . | <b>7</b> | Class Routine . . . . .                             | 18        |
| <b>English and Western Showmanship</b> . . . . .                | <b>7</b> | Tack and Attire . . . . .                           | 18        |
| Description . . . . .   | 7        | Basic Riding Position . . . . .                     | 18        |
| Class Routine . . . . .   | 7        | Position in Motion . . . . .                        | 19        |
| Tack and Attire . . . . .                                       | 7        | Scoring and Penalties . . . . .                     | 19        |
| Western . . . . .   | 7        | <b>Equitation Over Fences</b> . . . . .             | <b>20</b> |
| English . . . . .   | 7        | Description . . . . .                               | 20        |
| The Quarter System of Showmanship . . . . .                     | 8        | Class Routine . . . . .                             | 20        |
| Scoring and Penalties . . . . .                                 | 8        | Tack and Attire . . . . .                           | 20        |
| Patterns . . . . .  | 9        | Height of Fences . . . . .                          | 20        |
| <b>Draft Horse Showmanship</b> . . . . .                        | <b>9</b> | Scoring and Penalties . . . . .                     | 20        |
| Description . . . . .   | 9        | Knockdowns . . . . .                                | 21        |
| Class Routine . . . . .   | 9        | Course Design and Distances . . . . .               | 21        |
| Tack and Attire . . . . .                                       | 10       | <b>Reinsmanship</b> . . . . .                       | <b>21</b> |
|   |          | Description . . . . .                               | 21        |
|   |          | Class Routine . . . . .                             | 21        |
|   |          | Tack, Attire and Equipment . . . . .                | 22        |

|   |           |   |              |
|---|-----------|---|--------------|
| Basic Driving Position . . . . .          | 22        | <b>Dally Team Roping . . . . .</b>                | <b>27</b>    |
| Final Preparation . . . . .               | 22        | Description . . . . .                             | 27           |
| Gaits . . . . .                           | 22        | Tack, Attire and Equipment . . . . .              | 27           |
| <b>Draft Driving Guidelines . . . . .</b> | <b>23</b> | Class Rules . . . . .                             | 28           |
| Description . . . . .                     | 23        | Penalties . . . . .                               | 28           |
| Class Routine . . . . .                   | 23        | <b>Youth In Action . . . . .</b>                  | <b>28</b>    |
| Gaits . . . . .                           | 23        | State 4-H Horse Youth In Action Awards . . . . .  | 28           |
| Scoring and Faults . . . . .              | 23        | National Contest Eligibility . . . . .            | 28           |
| <b>Team Hitch . . . . .</b>               | <b>23</b> | State 4-H Hippology Contest Rules . . . . .       | 29           |
| Description . . . . .                     | 23        | Teams and Contestants . . . . .                   | 29           |
| Class Routine . . . . .                   | 23        | The Contest . . . . .                             | 29           |
| Basic Driving Position . . . . .          | 23        | Tie Breaking . . . . .                            | 30           |
| Scoring and Penalties . . . . .           | 24        | Resources . . . . .                               | 30           |
| <b>Timed Performance Events . . . . .</b> | <b>24</b> | State 4-H Horse Judging Contest Rules . . . . .   | 30           |
| <b>Barrel Racing . . . . .</b>            | <b>24</b> | Teams and Contestants . . . . .                   | 30           |
| Description . . . . .                     | 24        | The Contest . . . . .                             | 30           |
| Class Routine . . . . .                   | 24        | Rules and scoring . . . . .                       | 31           |
| Tack and Attire . . . . .                 | 24        | Tie Breaking . . . . .                            | 31           |
| Penalties . . . . .                       | 24        | State 4-H Horse Quiz Bowl Rules . . . . .         | 31           |
| Pattern Standards . . . . .               | 25        | Teams and Contestants . . . . .                   | 31           |
| <b>Pole Bending . . . . .</b>             | <b>25</b> | The Contest . . . . .                             | 31           |
| Description . . . . .                     | 25        | Questions . . . . .                               | 31           |
| Class Routine . . . . .                   | 25        | Match Procedures . . . . .                        | 31           |
| Tack and Attire . . . . .                 | 25        | Resources . . . . .                               | 32           |
| Penalties . . . . .                       | 25        | Scoring . . . . .                                 | 32           |
| Pattern Standards . . . . .               | 25        | Top Individual . . . . .                          | 32           |
| <b>Roping Events . . . . .</b>            | <b>26</b> | Quiz Bowl Scoring System . . . . .                | 32           |
| Calf Ruling . . . . .                     | 26        | State 4-H Horse Public Speaking Contest . . . . . | 32           |
| <b>Breakaway Roping . . . . .</b>         | <b>26</b> | Contest Rules . . . . .                           | 32           |
| Description . . . . .                     | 26        | State 4-H Horse Demonstration Contest . . . . .   | 33           |
| Tack, Attire and Equipment . . . . .      | 26        | Judge's Suggested Scoring System . . . . .        | 33           |
| Class Routine . . . . .                   | 26        | Premier Exhibitor . . . . .                       | 34           |
| Penalties . . . . .                       | 26        | Scoring Matrix . . . . .                          | 34           |
| <b>Tie Down Roping . . . . .</b>          | <b>26</b> | Tie Breaker . . . . .                             | 34           |
| Description . . . . .                     | 26        | <b>Appendix A . . . . .</b>                       | <b>35-39</b> |
| Tack, Attire and Equipment . . . . .      | 27        | <b>Appendix B . . . . .</b>                       | <b>40-63</b> |
| Class Rules . . . . .                     | 27        | <b>Appendix C . . . . .</b>                       | <b>64-79</b> |
| Penalties . . . . .                       | 27        |   |              |

**Horse Committee members:**

Amber Kolousek, Bonnie Rutten, Brian Burnham, Cecilia Steen, Hilary Schwagel, Jean Hommel Kessler, Jen Torsney, Kacy Goehring, Kristi Goehring, Lacey Hoekstra, Lesly Rygaard, Mandy Locken, Jennifer Martinez, Mary Kay Sell, Megan Schoeneman, Mysty Schaanamen, Steve Zoss, Heather Heying and Eris Jones



**SOUTH DAKOTA STATE  
UNIVERSITY EXTENSION**

# 4-H & Youth

**APRIL 2023**

SOUTH DAKOTA STATE UNIVERSITY®  
SDSU EXTENSION

## 2023 South Dakota 4-H Horse Project Show Guide

This manual is intended as a guide for 4-H leaders, extension staff, show managers and other individuals planning and conducting 4-H horse shows in South Dakota. Use it as a guide to learn about horse shows, establishing show rules and general show management. The South Dakota 4-H Horse project should be a positive experience for those who participate. The 4-H Youth Development Program reserves the right to the final and absolute interpretation of the rules and regulations.

Patterns listed in this book are to be used as suggested patterns for county horse shows. Beginners showing at the State 4-H Horse Show will use the pattern listed. Juniors will utilize one of the two patterns listed. Senior patterns for State 4-H Horse Show will be posted to [extension.sdstate.edu](http://extension.sdstate.edu) by July 15.

### Classes

The following will be the official classes at the State 4-H Horse Show. Contestants should enter classes within their age division whenever possible. County 4-H horse shows can add additional classes to best fit the needs and goals of their 4-H youth.

#### Showmanship

- Beginner Western Showmanship
- Junior Western Showmanship
- Senior Western Showmanship
- Beginner English Showmanship
- Junior English Showmanship
- Senior English Showmanship
- Junior Draft Horse Showmanship
- Senior Draft Horse Showmanship

#### Equitation

- Beginner Western Horsemanship
- Junior Western Horsemanship
- Senior Western Horsemanship
- Beginner Hunt Seat Equitation
- Junior Hunt Seat Equitation
- Senior Hunt Seat Equitation
- Junior Equitation Over Fences
- Senior Equitation Over Fences
- Junior Reinsmanship
- Senior Reinsmanship

#### Performance

- Junior Reining
- Senior Reining
- Junior Ranch Riding
- Senior Ranch Riding
- Beginner Trail
- Junior Trail
- Senior Trail
- Junior Single Draft Hitch
- Senior Single Draft Hitch
- Junior Team Hitch Driving

- 1. Miniature or Pony team
- 2. Horse team
- 3. Draft team
- Senior Team Hitch Driving
  - 1. Miniature or Pony team
  - 2. Horse team
  - 3. Draft team

### Timed Events

- Junior Barrel Racing
- Junior Pony Barrel Racing
- Senior Barrel Racing
- Junior Pole Bending
- Junior Pony Pole Bending
- Senior Pole Bending
- Junior Break-Away Roping
- Senior Break-Away Roping
- Senior Tie-Down Roping
- Senior Dally Team Roping

Note: A senior contestant may compete with a pony in any senior division event. A senior contestant may compete with a miniature horse in showmanship.

## General 4-H Rules

### Changes for 2023

Youth Horse Literacy has replaced the Horse Safety Program. Find more information on page 3-4.

Youth participating in Horse Youth in Action events only will no longer be required to complete Youth Horse Literacy.

Pleasure driving will now have a set pattern that will help improve the ability for judges to evaluate reinsmanship of youth drivers. To reflect this change, light horse pleasure driving will now be Junior Reinsmanship and Senior Reinsmanship. Patterns will be found in Appendix B and the score sheet can be found in Appendix C. Single draft driving and team hitch driving will have no changes.

Continuing in 2023, Premier Exhibitor. The award recognizes a more comprehensive development of the horse project knowledge. There will be one award for each of the three 4-H age divisions (beginner, junior, senior). For more information please refer to the Premier Horse Exhibitor Information on page 34.

To better meet needs of beginner participants, a beginner Hippology contest will be added.

Patterns for the following classes for Beginners and Juniors have been updated or added: Beginner Showmanship, Junior Showmanship Option 2, Junior Reining Option 2, Junior Ranch Riding Option 1 and Junior Reinsmanship Option 1 and 2.

### Insurance

All 4-H members must have on file in their County 4-H Office by May 31, of each year, a signed copy of the 4-H member insurance form. This document verifies the type of insurance coverage being provided for the 4-H member during the course of 4-H sponsored activities. Please check with your County 4-H Office regarding county requirements for health and accident insurance. No coverage will be provided at the State level. The South Dakota State Fair Commission and the 4-H Youth Development Program do not provide livestock or other exhibit insurance. Exhibitors are responsible for their own livestock or display exhibit insurance should they desire to carry coverage.

### Liability

Stanley County and the 4-H Youth Development Program use diligence to ensure safety of exhibits after items arrive and are placed on display; but in no case are they responsible for any loss or damage done to, occasioned by, or arising from, any animal or article in the exhibition, and exhibitors shall indemnify Stanley County and the 4-H Youth Development Program against all legal or other proceedings in regard thereto. Exhibitors should exercise caution and great care before deciding to exhibit family heirlooms and/or other highly valuable items.

### South Dakota 4-H Code of Animal Show Ring Ethics

South Dakota 4-H endorses and supports the International Association of Fairs and Expositions (IAFE) National Code of Show Ring Ethics. All exhibitors and their families agree to abide by this Code of Ethics and all rules and regulations printed in this rule book. Each exhibitor and their family are responsible for becoming familiar with those sections of the rule book that pertain to the area of their competition and abide by those rules at all times. The objectives listed within the Code of Ethics shall encourage all exhibitors and their families to maintain a high standard of ethics while competing at the South Dakota State 4-H Horse Show. Violation of rules will lead to penalties for exhibitors and their families which may include disqualification, barring from future shows,

and removal of awards. It is further consented and understood that any action in violation of these rules that also violates federal/ state/provincial status, regulations or rules may be released to appropriate law enforcement authorities with jurisdiction over such infractions.

### Local Determinations

The 4-H Youth Program Advisor, State 4-H Office, current county committee and/or program leader are responsible for initial rule interpretations and decisions. An individual should first notify the appropriate Area Chair of the grievance of a decision, protest of a rule, or policy infraction within seven (7) calendar days of notice of the incident. If the concern is not satisfied by local initial action or non-action within seven (7) calendar days of notification to the local decision maker, a written request is needed to initiate a formal protest or grievance.

### Protest Procedure

In accordance with the South Dakota 4-H Youth Development Program Interim Protest and Grievance and Policies document, protests at the State 4-H Horse Show will follow the policies and procedures found in the official SDSU Extension Civil Rights Plan document on [extension.sdstate.edu](http://extension.sdstate.edu). This policy is applicable to any protest or grievance related to application of 4-H rules, including by way of example but not exclusion, to State 4-H Horse Show protest and 4-H Code of Conduct violation allegations. This policy is not applicable to challenge judges' integrity, decisions, placements or other evaluations absent a rule violation.

The respective Show Chair has the authority to make appropriate decisions based on the current South Dakota 4-H Horse Project Show Guide. To allow for smooth operation of events, affected exhibitors may be allowed to participate in the event with the results subject to change based on the outcome of the Protest Procedure. 4-H Administration reserves the right to exclude exhibitors if warranted and withhold any awards in accordance with the Interim Protest and Grievance and Policies.

### Age Divisions for South Dakota 4-H Youth

| 4-H Age Division | Age on or before January 1 of the current 4-H program year |
|------------------|--|
| Beginner         | Age 8, 9, or 10  |
| Junior           | Age 11, 12, or 13  |
| Senior           | Age 14, 15, 16, 17, or 18                                  |

- Youth with special needs/disabilities are eligible to enroll. The County 4-H Office must notify the State 4-H Office in order for proper considerations to be made.
- Beginners may enter Junior classes if there is not a Beginner class listed.

## South Dakota 4-H Horse Project

### Purpose and Objectives of the 4-H Horse Program

Help the 4-H member:

- Develop leadership, initiative, self-reliance, sportsmanship and other desirable traits of character.
- Experience the pride and responsibility of having an equine while also learning about its care, feeding, management, and related costs.
- Appreciate horseback riding as a healthy and wholesome form of recreation.
- Gain skill in horsemanship, patience and understanding when humanely handling horses and ponies along with nurturing a greater love for animals.
- Acknowledge safety precautions to prevent injuries to themselves, others, and horses.
- Prepare for citizenship responsibilities by working together in groups and supporting community horse projects and activities.

The South Dakota 4-H Youth Development Program reserves final and absolute right to interpret the South Dakota 4-H Horse Project Show Guide rules and regulations and to arbitrarily settle and determine all matters, questions and differences in regard thereto, or otherwise arising out of or connected with or incident to the Show, and the right to amend or add to these rules as its judgment may determine.

### Youth Horse Literacy

The Youth Horse Literacy (YHL) certification event is required each program year for youth interested in exhibiting in a county horse show or the State Horse Show. This program will replace the former Horse Safety Program. The YHL program will not only allow youth to ensure safe handling and minimize risk around horses, but also allow them to gain a more comprehensive knowledge of their equine project.

The training must be completed by June 1 of each year. For more information, please refer to the [Youth Horse Literacy document](#) or your local 4-H Youth Program Advisor.

### Horse Ownership

References to horses throughout this project show guide mean all equine animals.

Horses of any breed or breed combination are acceptable for this project. Mares and geldings may be of any age. Stallions over 8 months of age may not be exhibited. Horses shall be serviceably sound and in good condition.

1. Any 4-H Horse member that plans to exhibit in any 4-H competition must have horse information loaded into 4-H Online by June 1 of each 4-H year. A member may register as many horses as they wish, however, only three horses may be used during the State 4-H Horse Show. A driving team will count as one horse for entry purposes.
2. Members must have managing control of their horse project. "Managing control" means overseeing proper feeding, grooming, exercising, training and stall management, and the member must have free access to the use of the horse at all times.
  - a. A 4-H member enrolled in the 4-H Horse project must have managing control of the horse by June 1. The horse may be owned solely by the 4-H exhibitor, or the exhibitor in partnership with other family member(s) of his or her immediate family, or leased for use as a 4-H project. If the horse is not owned, the 4-H member must complete the 4-H Animal Project Lease Form by June 1. This form should be uploaded to 4-H Online.

Injured horses and hardship cases: Youth are able to replace the horse they entered State Horse show with one they had registered prior to June 1 in 4-H Online. If prior to the State Show, please contact [sdsu.4h@sdstate.edu](mailto:sdsu.4h@sdstate.edu) with the horse originally entered, the horse from 4-H online to replace and the classes entered. Please note, depending on timeline of the show program, the horse's name will be the one originally entered.

For replacement rule at the State Horse show, contact show management.

## 4-H Horse Show Rules

All Horse Show exhibitors must abide by the South Dakota 4-H Code of Animal Show Ring Ethics and show rules listed in the South Dakota 4-H Horse Project Show Guide.

### General Rules

1. Rules in this manual will have precedence over all other rules. All rules and guidelines, as stated in the 4-H Horse Project Show Guide, are the official rules for the State 4-H Horse Show and should serve as guidelines for County 4-H Horse Shows. County 4-H horse shows can add additional classes to best fit the needs and goals of local 4-H youth.
2. In 4-H Horse projects, all breed of ponies, light horses, mules, draft or miniature horses may be used. To be eligible for participation in any 4-H Horse Show, the 4-H member must be enrolled in 4-H.
3. 4-H members, 4-H volunteers and adults are expected to adhere to the 4-H code of conduct at all times.
4. Violations of acceptable conduct by youth and adults will be dealt with by the show management and may result in disqualification from an event(s), awards or from the show. At any time, people behaving in an inappropriate manner may be asked to leave the show.
5. Show management may expel any person or persons abusing a horse from the grounds at any time. Entry fees and awards will be forfeited.
6. At no time should the contestants and/or parents confront the judge before or during the show. Contestants and/or parents may be allowed to contact the judge following the show at the discretion of show management. If contact with the judge is allowed, contestants and parents are to act in an appropriate manner.
7. Safety must be emphasized at all times, both in and out of the ring. The safety of spectators, contestants and their mounts must be the shared responsibility of all involved in the show.
8. Unruly horses will be dismissed at the judges' or show management discretion.
9. A contestant using a lame or otherwise unsound horse may be excused from the arena at the judge's and/or horse committee's discretion. If removed for obvious lameness, youth will not be eligible to show for the remainder of the day. A lameness check can be requested for participation the following day. Obvious lameness is defined as:
  - Consistently observable at a trot under all circumstances
  - Marked nodding, hitching or shortened stride
  - Minimal weight-bearing in motion or at rest; inability to move.
10. No exhibitor may be tied, buckled, or fastened into the saddle in any manner or by any means during competition, except in timed events where one rubber band not over ¼ inch may be used per foot. Exceptions are allowed if modifications are needed due to a physical or mental challenge.
11. Three refusals to enter the arena will result in disqualification in any event. A refusal is considered any step not going toward the ring (whether forward, sideways, or backwards). Any ring official—the judge, ring steward, or gate person, may call the disqualification.
12. All State 4-H Horse Show entries must be submitted through Fair Entry by 11:59 p.m. CST on July 1. Any fees should be sent by July 5th to the State 4-H Office. Only exhibitors and horses officially entered in the class will be allowed in the show ring while that class is being judged.
13. A fall of either horse or rider in the arena shall be cause for elimination from that class. A fall of the rider occurs when the rider is separated from his/her horse in such a manner as to require remounting. A horse is considered fallen when its shoulder touches the ground.
14. Any exhibitor/horse combination may not show or be shown more than once in any class or any event regardless of age division. English and Western Showmanship are not considered the same class; therefore, the same horse can be shown once in each of the classes.
15. Under ordinary conditions, equipment should not break during the performance, nor should it be changed after the class starts,

except on permission from the ring steward or judge. The judge may disqualify an exhibitor for broken equipment.

16. Any and all obstacles in any class may be adorned at the judge's discretion.

### **Horse Show Judges**

17. Judges will use and follow all rules and guidelines as stated in the 4-H Horse Project Show Guide.

18. Reasons/General critique will be given in every event at the State 4-H Horse Show then the awarding of Top 5 will follow. This will allow youth to understand the criteria the youth were judged on and allow the judge an explanation of his/her placing.

19. Judge's decisions are final.

20. The judge has the final authority on equipment and its use in accordance with the rule book.

21. The judge is the final authority related to handling of stock for roping events. If intentional rough handling is determined or if an exhibitor refuses to use legal equipment or uses altered legal equipment resulting in its failure, the exhibitor may be disqualified by the judge.

### **State Horse Show**

22. All protests or grievances at the State 4-H Horse Show must follow the protest procedure outlined by the SDSU Extension Civil Rights Plan.

23. Youth may enter as many classes and Youth in Action events they choose. The 4-H State Horse Committee and 4-H Staff will be unable to guarantee participation if scheduling conflicts occur.

### **Pony Measuring**

All ponies will be measured at the State 4-H Horse Show with an approved pony measurement stick. Ponies must be measured on a level surface. A concrete slab or other paved surface is more desirable but when not available, a heavy sheet of plywood or flat, solid surface can be used. The measurements will be submitted with the State 4-H Horse Show entries.

The pony must stand squarely on all four feet in such a position that the front legs are vertical to the ground and the back of the hocks are in a vertical line with the point of the hindquarters. The head must be held low enough to reveal the highest point of the withers and no lower. With the pony in that position, the vertical height is measured from the highest point of the withers to the ground.

1. Ponies (Over 38 inches to 56 inches at the withers)

2. Miniature horses (38 inches and under at the last mane hair)

### **Exhibitor Attire**

The standards of attire apply to all 4-H Horse Shows. Judges have the option to adjust rules due to conditions.

Properly worn ASTM/SEI (American Society for Testing and Materials/Safety Equipment Institute) approved headgear is strongly recommended for the exhibitors in any and all events and any time the rider is mounted.

Each exhibitor will be issued two identification numbers. The number is to be fastened on the back of the exhibitor, or on both sides of the saddle pad for riding classes so that it can be clearly seen by the judge. If the judge cannot read the number, the participant may be disqualified.

#### **Western Attire (for equitation, performance and timed events)**

1. A plain long-sleeve white, button shirt or blouse with collar (t-shirts are not acceptable, tuxedo shirts are acceptable) No silver or metal decorations, pins, scarves, or other adornments allowed on exhibitor's shirt.

2. Dark blue western style denim jeans and belt.

3. Western hat or any style of ASTM/SEI approved headgear must be worn in the arena at all times. There is no penalty for losing a hat during competition. Caps are not allowed.

4. Western boots – Western style lace-up boots are acceptable. Riding tennis shoes are not allowed.

5. Chaps, vests, gloves and similar accessories are prohibited. Spurs are prohibited in showmanship and driving. Spurs are optional in performance, equitation and timed events.

#### **English Attire**

1. Riders must wear boots, breeches, coat, and hunt cap or ASTM/SEI approved headgear.

2. Coats should be any tweed or melton (conservative wash jackets in season) acceptable for hunting.

3. High English boots or jodhpurs and jodhpur or paddock boots.

4. Long- or short-sleeve shirts with ties or chokers are preferred. Choker pins are acceptable.

5. Gloves are optional. Spurs are prohibited in showmanship and optional in performance and equitation classes.

#### **Driving Attire**

During reinsmanship, single draft hitch, and team hitch, drivers must follow either Western Attire rules or English Attire Rules.

1. Chaps or spurs are illegal.

2. Exhibitors may wear rainwear or inclement weather apparel if conditions warrant.

3. Exhibitors must carry a whip in their hand or in a whip holder.



## Youth in Action Attire

Western or English style dress for all events are acceptable. Hats are not allowed during Youth In Action Events.

## **Tack**

The use of artificial tail fans, artificial polls, false tails or the addition of any hair or hair-like substance to any part of the animal's body is prohibited.

### Curb Bits

- Maximum shank length overall is 8½ inches. Shanks can be fixed or loose.
- Mouth pieces must have smooth, round bars or unwrapped metal, and measure between ⅜ and ¾ inches in diameter when measured 1 inch from cheek. They may be inlaid but must be smooth or latex wrapped. Nothing may protrude below the mouthpiece (bars), such as extensions or prongs on solid mouthpiece. Mouthpiece may be 2 or 3 pieces. If 3 piece, a connection ring of 1¼ inch or less in diameter, or a connection flat bar of ⅜ to ¾ inch (measured top to bottom with a maximum length of 2 inches), it must lie flat in horse's mouth.
- Ports may not exceed a maximum of 3 inches in height. Rollers (⅜ to ¾ inch diameter) and covers are acceptable. Grazing, broken mouthpieces, half breeds, and spades are standard. Bits with gag action are illegal, except in speed and timed events. (Barrel racing, pole bending, and roping)
- All mechanical hackamores are illegal except in speed and timed events.

### Snaffle Bits and Bosals

- May be used only for horses 5 years and younger.
- Horses are to be shown in a true snaffle (conventional O-ring, egg butt or D-ring) or bosal. The bit must have a smooth broken mouthpiece. The mouthpiece must be at least 5/16 inch in diameter, measured 1 inch from the corner of the mouth piece. Curb straps are optional. When used, the straps must be loosely attached, meet the 4-H requirements and be attached below the reins.
- Bosals must be of braided leather, braided rawhide or rope. Absolutely no iron under the jaw, regardless of how padded or taped. Jaquimas are acceptable.

### Curb chains and straps

- Curb chains and straps must be flat with a minimum width of ½ inch.
  - Round leather curb straps, braided knots, or flat braided curb straps are illegal.
  - Any twisted chain or strap is illegal.

### Reins

- Split reins or romal must be used . A romal may be used with closed-type reins. Romals must be of sufficient length to allow a minimum of 16 inches between the rein hand and the free hand holding the romal.
- Roping reins will be allowed in speed and roping events.

### Riding Restraints

- Running or standing martingales, tie-downs, nosebands, cavessons or draw reins are illegal except in speed and timed events (barrel racing, pole bending, roping).

### Leg Wear

- Horse leg wear is optional in Equitation Over Fences, Reining, Barrels, Poles, Tie Down Roping, Break Away Roping and Team Roping. Horse leg wear is not allowed in Showmanship, Western Horsemanship, Hunt Seat Equitation, Driving (reinsmanship, single draft, team hitch), Ranch Riding and Trail classes.

Please see Appendix A for visual examples of legal and illegal tack.

## **Award System**

4-H members are awarded based on how well their performance compared to that of an ideal performance. The judge will place contestants in one of the four ribbon placing groups. Judging in all classes, except timed events, is based on the performance of the horse and rider. Performance should show that the exhibitor has worked with their horse and has shown proficiency that they are working as a team. A judge will watch the horse/ rider team perform a pattern to display their skill. The judge will view each exhibitor with the listed scoring system and award ribbons based on the Danish system as described below. The judging is looking for:

1. Correctness
2. Quality
3. Degree of difficulty (control)

| <b>Ribbon</b> | <b>Designation</b>  |
|---------------|---|
| Purple        | Superior - A performance that met all of the class requirements. Contained few, if any, flaws.  |
| Blue          | Excellent - A performance that met all of the class requirements. The performance contained few flaws and was well above minimum standards.   |
| Red           | Average - The performance was slightly above or at minimum standards. Although displaying good effort, the performance contained several flaws.   |
| White         | Room for Improvement - Performance was below minimum standards. The performance contained several flaws and considerable room for improvement exists or the exhibitor was disqualified. |

## Pattern classes for Equitation and Performance

Patterns can be found in Appendix B.

For each class: Beginners will have one pattern listed that will be used at the show. Juniors will have two patterns listed, one will be used and will be announced on SDSU Extension website by July 15. For senior members, the judge will select a pattern to be used. Pattern will be posted on the SDSU Extension website by July 15.

County shows may use the listed patterns or other patterns at discretion of judge or show committee.

## English and Western Showmanship

### Description

Showmanship is judged on how effective the 4-H member presents a well-groomed, willing animal and the accuracy through which the team (horse and handler) presents a pattern to a judge. Any breed of pony, horse (light and draft) or miniature horse may be used. In showmanship at halter, the confirmation of the horse is not judged. Video resource: [youtube.com/watch?v=1F0jE6Be0NQ](https://www.youtube.com/watch?v=1F0jE6Be0NQ)

### Class Routine

All exhibitors may enter the ring and then work individually or each exhibitor may be worked from the gate individually. With either routine, each showman will complete the pattern individually. The horse is always led from the left side. All turns should be to the right, with exhibitor pushing the horse away from them. Maneuvers that are considered acceptable: leading horse at walk, jog/trot, extended trot, back, turn, stop, and set up for inspection. During inspection the Quarter System will be used. Following the completion of the pattern, he/she will follow the instruction of the ring steward.

### Tack and Attire

Correct tack does not build points; however, incorrect tack can result in lower placings.

#### Western

- Refer to Page 5 for Western Attire
- Halter – may be leather, rope or nylon. Must be clean and adjusted to fit.
- Lead – should be 6 to 7 feet long, neat and inconspicuous. The judge may penalize an exhibitor for excessive or abusive use of chain lead or for holding the chain portion of the lead with their hand. The excess lead should be made into a loop.

#### English

- Refer to page 5 for English Attire.
- Bridles – snaffle (without flash, crossed figure-8, or dropped nose-band), Pelhams, or full bridle.
- Lead – on full bridles: option to show off either snaffle or curb; on Pelhams: with four reins, options to show off either set, non-leading rein to be draped over withers in both situations.

## The Quarter System of Showmanship

The following suggested guidelines of movement are meant to serve as an illustration of proper movement around the horse while showing in Showmanship and are for exhibitor information. The quarter system is not used in Draft Horse Showmanship.

Imaginary lines divide the horse into four equal parts as seen in the figure below. (Note: The horse has been sectioned into four quadrants numbered I, II, III, and IV for ease of identification.) One line runs across the horse behind the withers. The other imaginary line runs from head to tail. When the judge is in I, the exhibitor should be in IV. As the judge moves to II, the exhibitor should move to I. When the judge moves to III, the exhibitor moves to IV. As the judges move up to IV, the exhibitor returns once more to I. This method is based on safety as the exhibitor can keep the horse's hindquarters from swinging toward the judge.

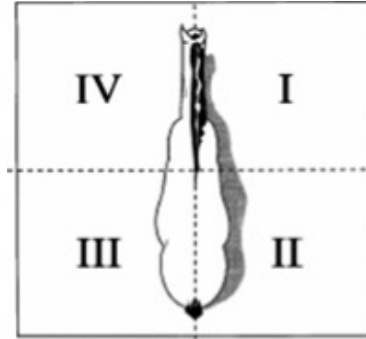

**Scoring and Penalties** (The score sheet used for Showmanship (English & Western) at the South Dakota 4-H Horse Show can be found in Appendix C.)

- Exhibitors will be scored from 0 to 100 with 70 denoting an average score. Half point increments are acceptable. Maneuver scores will be indicated as follows:
  - +3 = Excellent
  - +2 = Very Good
  - +1 = Good
  - 0 = Correct
  - 1 = Poor
  - 2 = Very Poor
  - 3 = Extremely Poor
- The Form and Effectiveness score ranges from 0 to 5. The F&E score is awarded by the judge on their overall impression of the run. This number is added to the score at the end of the run.
  - 0-2 = Average
  - 3 = Good
  - 4 = Very Good
  - 5 = ExcellentAn approximate break down of the scores shall be as follows:
  - 90-100 Excellent showmanship, including body position and presentation of horse. Completes pattern accurately, quickly, smoothly and precisely; demonstrates a high level of professionalism
  - 80-89 Very Good performance in execution of the pattern as well as correct showmanship and presentation of horse. Excellent showman that commits a major fault.
  - 70-79 Good pattern execution and average showmanship; lacking adequate style and professional presentation to merit elevating to the next scoring range. A very good showman that commits a major fault or an excellent showman that commits a severe fault.
  - 60-69 Fair pattern that lacks quickness or precision. Horse with consistently unwilling attitude or handler with obvious position and/or presentation faults that prevents effective showmanship. A good showman that commits one major fault in the performance of the pattern. A very good showman that commits a severe fault.
  - Less than 59 Good showman that commits one severe or multiple major and/or minor faults; excellent or very good showman that commits multiple, and/or combination of, severe, major or minor faults in the performance or presentation or position of exhibitor that precludes effective communication with the horse.
  - Suggested ribbons
    - 80+ Purple
    - 70-79 Blue
    - 60-69 Red
    - <59 White

### 3. Faults

- a. Minor Faults Three (3) point penalties:
  - i. Break of gait at walk or trot for up to two strides
  - ii. Over or under turning up to  $\frac{1}{8}$  of a turn
  - iii. Ticking or hitting cone
  - iv. Sliding a pivot foot
  - v. Lifting a pivot foot during a pivot or set-up and replacing it in the same place
- b. Major Faults Five (5) point penalties:
  - i. Not performing the gait or not stopping within 10 feet of the designated area
  - ii. Break of gait at walk or trot for more than 2 strides
  - iii. Splitting the cone (cone between the horse and handler)
  - iv. Horse stepping out of or moving the hind end significantly during a pivot or turn
  - v. Horse stepping out of set-up after presentation
  - vi. Over/under turning  $\frac{1}{8}$  to  $\frac{1}{4}$  turn
- c. Severe Faults Ten (10) point penalties – (Could earn white ribbon)
  - i. Exhibitor is not in the required position during inspection
  - ii. Exhibitor touching the horse or kicking or pointing their feet at the horse's feet during the set-up
  - iii. Standing directly in front of the horse
  - iv. Loss of lead shank, holding chain or two hands on shank
  - v. Severe disobedience including rearing or pawing; horse continually circling exhibitor
- d. Disqualifications (Will receive a white ribbon)
  - i. Loss of control of horse that endangers exhibitor, other horses or judge
  - ii. Horse becomes separated from exhibitor
  - iii. Failure to display correct number
  - iv. Willful abuse
  - v. Never performing specific gait
  - vi. Excessive schooling or training; use of artificial aids
  - vii. Knocking over the cone or going off pattern
  - viii. Illegal equipment
  - ix. Over or under turning by more than  $\frac{1}{4}$  turn

#### Patterns

- Beginners and Juniors will use patterns found in Appendix B. County horse shows may use any pattern listed or at the discretion of judge or show committee.
- The judge will select a pattern to be used for Western and English Senior Showmanship. The same pattern must be used for all exhibitors in the class. Pattern will be posted on the SDSU Extension website at [extension.sdstate.edu](http://extension.sdstate.edu) by July 15. A different pattern may be used in a finals round. The selection of patterns at county shows will be at the discretion of the judge and show committee.

## Draft Horse Showmanship

### Description

The purpose of Draft Horse Showmanship is to show a clean, thrifty, well-cared-for condition, in a positive manner.

### Class Routine

After showing your horse on the move, stop the horse and set the horse up. The quarter system is not used in Draft Horse Showmanship. Exhibitor should hold lead strap in right hand and show stick in left hand when leading the horse. When moving with the horse, its head should be even with the exhibitor's right shoulder. When setting up the horse, exhibitor should turn so the left shoulder is next to the horse. Change the lead to the left hand with show stick in right hand. When setting up and showing the horse, the lead should always be in the left hand. Return to the line after the judge excuses you. Horses should be shown with all four feet positioned correctly under the body while in line. The judge will closely inspect and may handle each horse. A trailer (person to assist with moving the horse) with or without a whip is permitted. The trailer should cross to the opposite side prior to the turn and should never get between the judge and the horse when the horse is in line but should stand behind the exhibitor some distance away and may assist in keeping the horse alert.

Horses enter the ring at the trot and line up side-by-side at the direction of the ring steward. Juniors will use patterns found in Appendix B. Seniors will be posted by July 15th on the, SDSU Extension website at [extension.sdstate.edu](http://extension.sdstate.edu).

Deviations from this description may be necessary and will be announced prior to the beginning of the class.

## Tack and Attire

- Refer to page 5 for Attire.
- Halters and leads may be of leather, nylon or rope and should be clean and fitted to the horse.
- Show sticks and bridles will be allowed.
- Tails may be natural or docked, braided or left long, but fit to the proportions of the horse.
- Manes may be rolled and decorated.
- Feet may be shod or unshod, but should be properly trimmed and clean.
- Black or natural hoof paint is acceptable.

## Western Horsemanship

### Description

The Western Horsemanship class recognizes the rider's ability to ride a horse correctly and to use various aids required for a horse to perform basic maneuvers. Riders will be judged on basic position in saddle, position and use of hands, legs and feet, ability to control and show the horse, and suitability of horse to rider. Grooming standards are consistent with showmanship. Video resource: [youtube.com/watch?v=eQVV3jRFjx4](https://www.youtube.com/watch?v=eQVV3jRFjx4)

### Class Routine

In all South Dakota 4-H Horse Shows, classes will begin with individual pattern work. Additional rail work or pattern is at the judge's discretion. If rail work is called for, it should include a flat-footed, four-beat walk, two-beat jog, and a three-beat lope displaying the correct lead. Contestants should stay near the rail at all times and use the entire arena. If a contestant needs to pass another horse, pass on the inside of the ring. Beginners will be walk/jog only and be limited to the patterns found in Appendix B. Juniors will be limited to the patterns found in Appendix B. Seniors pattern will be posted by July 15 on the SDSU Extension website at [extension.sdstate.edu](http://extension.sdstate.edu).

### Tack and Attire

- Refer to Tack and Attire on pages 5-7.
- Saddles - Must be sized to the rider and of western type.
- Prohibited Tack: mechanical hackamore, draw reins, tie-downs, martingale, cavesson noseband, protective boots or leg wraps, or roping reins.

### Hand Set

- Reins are to be used with one hand and the rein hand must not be changed during the class. EXCEPTION: Two hands may be used when using a ring snaffle or bosal on horses 5-years-old and younger.
- Split reins should be held with the hand around the reins with one finger permitted between the reins. Reins may enter the hand under the little finger, up across the palm and out over the index finger or thumb. They may also enter over the index finger and down across the palm and out below the little finger.
- When using both hands on the reins of a snaffle bit or hackamore, the reins may or may not be crossed. The rider's hand should be carried near the pommel and no further than 4 inches out on either side of the saddle horn. Rider's hands must be steady with very limited movement.
- When using a romal, no finger is allowed between reins. Rider can hold romal with the hand not used for reining, provided it is held approximately sixteen inches from the reining hand.
- Two handing reins for horses shown in a shank bit, a finger between romal reins, or more than one finger between split reins will result in a "no score" which is a disqualification for all Western Performance classes.
- Horses shall be shown on a reasonably loose rein. Extremes (too tight or too loose) shall be penalized. Dropping a rein that contacts the ground while the horse is in motion will result in a "no score" which is a disqualification for all Western Performance classes.

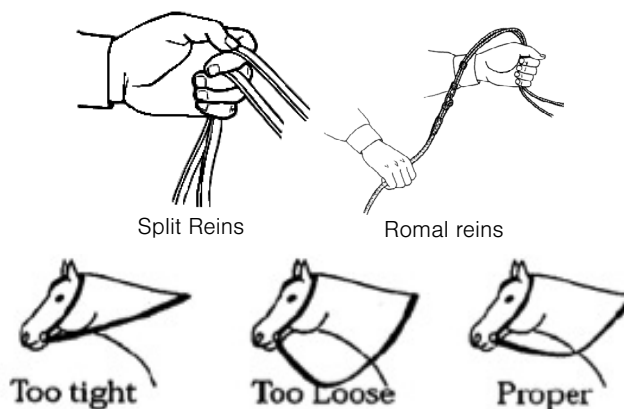

## Basic Riding Position

Rider should sit in the saddle with:

- Legs hanging straight and slightly forward of stirrups.
- Knees slightly bent and weight directly over balls of feet.
- In either position the stirrup should be short enough to allow the rider's heels to be lower than their toes.
- Body should always appear comfortable, relaxed and flexible.
- Feet should be placed in the stirrup with weight on ball of the foot. Consideration, however, should be given to the width of the stirrups, which varies. If stirrups are wide, the foot may have the appearance of being "home," when in reality the weight is properly carried on the ball of the foot.

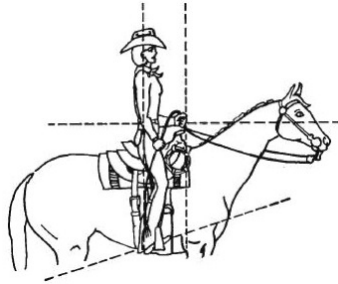

## Position in Motion

Rider should sit the jog and not post. The rider should be close to the saddle at the lope. All movements of the horse should be governed by the use of imperceptible aids. Exaggerated shifting of the rider's weight is not desirable.

## Scoring

1. The score sheet used for Western Horsemanship at the South Dakota 4-H Horse Show can be found in Appendix C. Exhibitors will be scored from 0 to 100 with 70 denoting an average score. One-half point increments are acceptable. Maneuver scores will be indicated as follows:
  - +3 = Excellent
  - +2 = Very Good
  - +1 = Good
  - 0 = Correct
  - 1 = Poor
  - 2 = Very Poor
  - 3 = Extremely Poor
2. The Form and Effectiveness score ranges from 0 to 5. The F&E score is awarded by the judge on their overall impression of the run. This number is added to the score at the end of the run.
  - 0-2 Average
  - 3 Good
  - 4 Very Good
  - 5 ExcellentAn approximate break down of the scores shall be as follows:
  - a. 90-100 Excellent rider, including body position and use of aids. Completes pattern accurately, quickly, smoothly and precisely while demonstrating a high level of professionalism.
  - b. 80-89 Very Good performance in execution of the pattern as well as correct horsemanship and use of aids. Excellent horseman that commits a major fault.
  - c. 70-79 Good pattern execution and average horsemanship lacking adequate style and professional presentation to merit elevating to the next scoring range. A very good rider that commits a major fault or an excellent rider that commits a severe fault.
  - d. 60 – 69 Fair pattern that lacks quickness or precision or rider has obvious position and/or appearance faults that prevents effective horsemanship; or a good horseman that commits a major fault in the performance of the pattern. A very good rider that commits a severe fault.
  - e. Less than 59 Good pattern with one severe or multiple major/minor faults; excellent or very good rider that commits multiple, and/or combination of, severe, major or minor faults in the performance. A rider that demonstrates a lack of riding ability and knowledge of correct body position.
  - f. Suggested ribbons
    - i. 80+ Purple
    - ii. 70-79 Blue
    - iii. 60-69 Red
    - iv. <59 White

3. Faults:
  - a. Minor faults Three (3) point penalties:
    - i. Break of gait at walk or jog/trot up to 2 strides
    - ii. Over/under turn from 1/8 to 1/4 turn
    - iii. Tick or hit of cone
    - iv. Obviously looking down to check leads
  - b. Major faults Five (5) point penalties:
    - i. Not performing the specific gait or not stopping when called for in the pattern within 10 feet of the designated area
    - ii. Incorrect lead or break of gait (except when correcting an incorrect lead) at the lope
    - iii. Break of gait at walk, jog or trot for more than two strides
    - iv. Loss of stirrup
    - v. Head carried too low and/or clearly behind the vertical while the horse is in motion, showing the appearance of intimidation
  - c. Severe Faults Ten (10) point penalties:
    - i. Loss of rein
    - ii. Use of either hand to instill fear or praise while on pattern or during rail work
    - iii. Holding saddle with either hand
    - iv. Cueing with the end of the romal
    - v. Blatant disobedience including kicking, pawing, bucking and rearing
    - vi. Spurring in front of cinch
  - d. Disqualifications (Will receive a white ribbon)
    - i. Failure to display correct number
    - ii. Abuse of horse or schooling
    - iii. Fall by horse or rider
    - iv. Illegal equipment or illegal use of hands on reins
    - v. Use of prohibited equipment
    - vi. Off pattern, including: knocking over cone or wrong side of cone or marker; never performing designated gait or lead; over or under turning more than 1/4 turn.

## Ranch Riding

### Description

Ranch Riding serves to measure the ability of the horse to be functional and a pleasure to ride at a working speed while being used as a means of conveyance from one western stock horse task to another. The horse's performance should simulate a horse riding outside the confines of an arena and that of a working ranch horse. This horse should be well-broke, relaxed, quiet, soft, and cadenced at all gaits. The horse should be responsive to the rider, yield to contact, and make all required transitions smoothly, timely, and correctly. The horse should perform with reasonable speed and be obedient, well-mannered, free, and easy-moving. Video resource: [youtube.com/watch?v=cqLiRpZSi0Y](https://www.youtube.com/watch?v=cqLiRpZSi0Y)

### Class Routine

Class consists of pattern work which is ridden individually. For each maneuver, the horse is judged on quality of gaits, response to the rider, manners, and disposition. Maneuvers may include:

1. Walk, trot, and lope both directions
2. Extended trot and extended lope at least one direction
3. Stop and back from any gait
4. Side pass
5. Turns on the hindquarters of up to 2.5 turns
6. Turns on the forehand of up to 180 degrees
7. Change of lead (simple or flying)
8. Walk, trot, or lope over a pole(s)

For State 4-H Horse Show, Juniors will use patterns listed in Appendix B. Seniors will be posted by July 15 on the, SDSU Extension website at [extension.sdstate.edu](http://extension.sdstate.edu).

### Tack and Attire:

- Refer to Tack and Attire on pages 5-7.
- Prohibited: Mechanical hackamore, draw reins, tie-downs, martingale, cavesson noseband, protective boots or wraps, and roping reins.
- Discouraged equipment: Hoof polish, trimming inside of ears, banded or braided mains, excessive silver show tack.
- Optional equipment: Rope.

## Scoring

1. The score sheet used for Ranch Riding the South Dakota 4-H Horse Show can be found in Appendix C. Horse will be given credit for traveling with his head held in a normal position, ears alert, and moving at a natural speed for the gait requested. The horse should be ridden on a relatively loose rein with light contact and without requiring undue restraint. Excessively long reins will be penalized.
2. All transitions should be smooth without undue exaggeration or resistance from the horse.

Scoring will be on a basis of 0-100, with 70 denoting an average performance. The individual maneuvers are scored in half-point increments:

- +1 ½ Excellent
- +1 Very Good
- +½ Good
- 0 Correct
- ½ Poor
- 1 Very Poor
- 1 ½ Extremely Poor
- a. One (1) point penalties:
  - i. Too slow/per gait
  - ii. Over-bridled
  - iii. Out of frame
  - iv. Break of gait at walk or jog for 2 strides or less
  - v. Split leg at lope
- b. Three (3) point penalties:
  - i. Break of gait at walk or jog for more than 2 strides
  - ii. Break of gait at lope
  - iii. Wrong lead or out of lead
  - iv. Draped reins
  - v. Out of lead or cross-cantering more than 2 strides when changing leads
  - vi. Trotting more than 3 strides when making a simple lead change
  - vii. Severe disturbance of any obstacle
- c. Five (5) point penalties
  - i. Blatant disobedience (kick, bite, buck, rear, etc.)
- d. Placed below horses performing all maneuvers (Likely white ribbon)
  - i. Eliminates maneuver
  - ii. Incomplete maneuver
- e. Zero score (Will receive white ribbon)
  - i. Illegal equipment
  - ii. Willful abuse
  - iii. Major disobedience or discipline
- f. Suggested ribbons
  - i. 80+ Purple
  - ii. 70-79 Blue
  - iii. 60-69 Red
  - iv. <59 White

## Ranch Riding Terminology:

- a. Walk – The walk should be straight, square, flat-footed, relaxed with the horse moving out freely and looking ahead.
- b. Trot – This gait should be a square two-beat diagonal trot. The trot should be steady, soft, and slow enough for riding long distances. Trots which are rough and hard to sit could be penalized. Excessively slow and uncadenced trots could be penalized.
- c. Extended trot – The extended trot should show an evident lengthening of stride from the regular trot with the same cadence that will cause an increase in speed. This trot should be level, flat, and steady with the appearance that the horse could hold this gait for an extended distance. Rider may post or sit the extended trot. Holding the saddle horn is permissible at this gait, as might be done in open terrain. When transitioning from the extended trot to the lope, it is permissible to take the horse back a bit (collecting) before loping.
- d. Lope – This gait should be a three-beat gait that is cadenced, straight, and steady and is comfortable to ride over long distances.
- e. Extended lope – The extended lope should be an obvious lengthening of stride from the previous lope, be at the same cadence and cause an increase in speed. The gait needs to be steady, quiet, and maintain the increased speed while being under control.
- f. Natural gait and Extended natural gait – Non-trotting horses should perform their natural gait where a job/trot is indicated and show a distinctive difference in speed of that gait where an extended job/trot is asked. The natural gait should be smooth and appear effortless for riding long distance.



- g. Stop (from both lope and trot) – the horse should be in the correct stopping position, both hocks engaged and stopping on the hindquarters.
- h. Reverse and turns – A horse should turn briskly and flat with front feet close to the ground and holding an inside rear pivot foot.
- i. Turn on the forehand – Hind end should move around with minimal movement of the front feet
- j. Side pass – A smooth, fluid, sideways movement with a clean cross-over in front and behind.

## Reining

### Description

Reining is a class that combines precision, style, speed, agility and brokenness. Each horse is judged on style, ability, ease, and degree of difficulty it performs prescribed patterns. Horses should guide easily with little to no apparent resistance throughout the entire pattern. Juniors will be limited to the patterns found in Appendix B. Seniors pattern will be posted by July 15th to the SDSU Extension website. Video resource: [youtube.com/watch?v=QRYtMhjb7A4&t=11s](https://www.youtube.com/watch?v=QRYtMhjb7A4&t=11s)

### Class Routine

Each contestant is to perform the required pattern individually and separately. All horses are to be judged immediately upon entering the area; judging ceases after the last maneuver. The horse shall rein and handle easily, fluently, effortlessly and with authority in performing the various maneuvers while using controlled speed.

### Tack and Attire

- Refer to Tack and Attire on pages 5-7.
- Prohibited Equipment: Mechanical hackamore, martingale, tie-down, draw reins, cavesson nosebands, or roping reins.
- Optional: Protective boots, skid boots, or leg wraps.

Excess rein may be straightened at any place a horse is allowed to be completely stopped during a pattern. Use of the free hand any time the horse is not completely stopped is considered to be the use of two hands and a score of zero will be applied.

### Scoring and Penalties

The score sheet used for reining at the South Dakota 4-H Horse Show can be found in Appendix C. Scoring will be on the basis of 0 to infinity, with 70 denoting an average performance. The individual maneuvers are scored in ½ point increments:

- +1 ½ Excellent
- +1 Very Good
- +½ Good
- 0 Correct
- ½ Poor
- 1 Very Poor
- 1 ½ Extremely Poor

### Penalty Scores:

0 or "DQ" (Will receive white ribbon)

- More than index finger between reins.
- Use of two hands (except in a snaffle).
- Failure to complete the pattern as written.
- Jogging in excess of half circle or half the length of the arena.
- Over spins of more than ¼ turn.
- Fall to the ground by horse or rider. Fall of horse is defined as shoulder and/or hip and/or underline touches the ground.
- Dropping a rein that contacts the ground while the horse is in motion.
- Failure to wear appropriate western attire.

Five (5) point penalties

- Spurring in front of the cinch.
- Use of either hand to instill fear or praise.
- Holding saddle horn.
- Blatant disobedience including kicking, biting, bucking rearing and striking.

Two (2) point penalties

- Break of gait.
- Freeze up in spin or rollback.
- On walk in patterns, cantering prior to reaching the center of the arena and/or failure to stop or walk before executing a canter departure.
- On run in patterns, failure to be in a canter prior to reaching first marker.
- If a horse does not completely pass the specified marker before initiating the stop position.

One (1) point penalties

- Each time horse is out of lead (accumulative, one point for each quarter of a circle or any part thereof).
- Over/under spinning  $\frac{1}{8}$  to  $\frac{1}{4}$  of a turn.
- Missing center
- Failure to remain a minimum of twenty (20) feet from fence.

Half ( $\frac{1}{2}$ ) point penalties

- Delay lead change for one stride
- Starting circles at jog or exiting rollbacks at jog for up to two strides
- Over/under spinning up to  $\frac{1}{8}$  of turn

Suggested ribbons

- 80+ Purple
- 70-79 Blue
- 60-69 Red
- <59 White

### Reining Terminology

- Circles: Maneuvers at the lope, of designated size and speed, which demonstrate control, willingness to guide and degree of difficulty in speed and speed changes. Circles, performed at a lope, are run in a designated location at a defined speed and size with a common center point (usually the center of the arena even with the center marker). All large, fast circles should be of consistent speed and size. All small, slow circles should also be of a consistent speed and size. Circles should be circles, not egg or elliptical shaped.
- Flying Lead Changes: The act of changing the leading (or inside) front and rear pair of legs when changing the direction of travel. To be considered correct, this maneuver must be performed at a lope with no change of gait or speed, be performed at exact location as specified by the pattern and the change must take place on both the front and rear legs in the same stride.
- Sliding Stop: The rider, while loping, cues the horse to stop. The horse brings back legs up underneath in a locked position that will cause it to begin sliding on the back feet. The horse maintains forward movement by continuing to run with the front feet and using the head and neck to balance. Throughout the stop, the horse continues in a straight line while the back feet slide over the ground.
- Rundown: The horse gallops or "runs" down the side or center of the arena. A run down is a required movement before a sliding stop or roll back.
- Rollback: The horse runs to a stop, rolls the shoulders back in the opposite direction completing a 180 degree ( $\frac{1}{2}$  turn) reversal of forward motion and departs in a canter. This is all one continuous motion with no hesitation.
- Spins: The horse is asked to turn the front end around in a series of 360-degree turns, executed while the inside back foot remains in one spot. Correctly done, the horse will cross the outside front leg over the inside front leg, effortlessly moving the front end around in a smooth, flowing manner. Higher marks are given to the horse that shows no resistance.
- Pause/Hesitate: The horse is asked to stand still for a few seconds to "settle" between certain movements in the reining pattern. Pauses are not judged as a movement per se, but a horse that is ill-mannered or behaves with impatience when asked to wait will be penalized.

### Pattern Clarification

Markers will be placed along both walls/fences with the center cone to be placed first and the end cones to be placed equal distance from the center cone. The judge will indicate where to place the markers.

Patterns are worked as stated, not as drawn. The drawing is provided to give the general idea of what the pattern will look like in the arena. Each pattern is drawn so that the bottom of the drawing represents the end of the arena entered by contestants and must be run as such. If the arena has only one gate and it is in the exact middle of a side, that side represents the right side of the page the pattern is drawn on and the contestant must walk to the end of the arena to begin the pattern.

Where designated in the pattern for stops to be beyond a marker, the horse should begin the stop after passing the specified marker.

## **Trail**

### **Description**

Trail is judged on the performance of the horse over obstacles. Emphasis is placed on manners, response to rider's cues and ability to maneuver through the course with style and precision. The judge will credit a horse that is attentive and able to make way through obstacles with minimal rider input. Beginner and Juniors will be limited to the patterns found in Appendix B. Seniors pattern will be posted to the SDSU Extension website at [extension.sdstate.edu](http://extension.sdstate.edu) by July 15. Video resource: [youtube.com/watch?v=M7xlt65-1VY](https://youtube.com/watch?v=M7xlt65-1VY)

**NOTE:** County horse shows may modify listed patterns to fit equipment available.

## Class Routine

This is strictly an individual pattern class; no rail work.

A minimum of six obstacles will be used, three mandatory and three others selected from the approved list or by request of the judge. Each mandatory obstacle (except gate) must be cleared within 30 seconds of entering the obstacle or the contestant will be dismissed from the ring. No rail work will be used.

The judge has the option of limiting performance at any optional obstacle to two approaches or 30 seconds.

Reins are to be used with one hand (with the exception of using a bosal or ringed snaffle), and the rein hand must not be changed during the class except when working the gate or under direction of the pattern.

Beginner trail is walk/jog only. Beginners will ride through an open gate. A walk-through will be available prior to the start of the class for each age group, during the State Horse Show. County shows are at the discretion of the judge and show committee.

**Note:** Only exhibitors will be allowed in the ring during the final walk-through. No coaches or advisors are allowed on the course.

## Tack and Attire

- Refer to Tack and Attire on pages 5-7.
- Prohibited: Mechanical hackamore, draw reins, tie-downs, martingale, cavesson noseband, protective boots or wraps and roping reins.

## Mandatory Obstacles

1. Opening gate (see \* below), passing through and closing gate (45-second time limit). Changing hands on gate or turning loose of gate is to be penalized.
  - Counties have the option to use a wooden or rope gate at their county 4-H horse show.
  - The gate shall be freestanding and may be 6-8 feet wide, with no feet restricting supports. Suggested gate assembly: use two pole-bending poles, weighted properly, with a rope securely tied to one pole and easily slipped over the other.
  - Gate type (wooden or rope) must be specified on show pattern.
2. Ride over at least four logs or poles (30-second time limit). These can be in a straight line, curved, zigzag or raised (not greater than 12 inches). The distance between the poles is measured over the horse's path and shall be 15 to 24 inches for walkovers, 3 to 3 feet 6 inches for trot-overs, and 6 to 7 feet for lope-overs. Elevated walkovers shall be a minimum of 22 inches apart.
3. Ride over wooden bridge (30-second time limit). The sides on the bridge for Trail need to be removed to create a flat bridge with no sides on for safety reasons.
  - \* **NOTE:** For safety reasons, Beginners are to ride through an open gate and leave the gate open. Beginner contestants will trot instead of lope.

## Optional Obstacles

- Water hazard (ditch or shallow pond).
- Hobble or ground-tie horse.
- Carry object from one part of the arena to another.
- Back horse through "L" shaped course (minimum of 28 inches).
- Handle slicker.
- Open and close mailbox.
- Dismount and lead horse over obstacles no less than 14 inches and no more than 24 inches in height.
- Pull an object toward the horse with lariat or rope.
- Others upon request of the official judge.

## Scoring

The score sheet used for Trail at the South Dakota 4-H Horse Show can be found in Appendix C. Scoring will be on the basis of 0 to infinity, with 70 denoting an average performance. Each obstacle will receive an obstacle score that should be added or subtracted from 70 and is subject to a penalty that should be subtracted. Each obstacle will be scored on the following basis, ranging from plus 1½ to minus 1½:

- 1 ½ Extremely poor
- 1 Very Poor
- ½ Poor
- 0 Correct
- +½ Good
- +1 Very Good
- +1 ½ Excellent

The Form and Effectiveness score ranges from 0 to 5. The F&E score is awarded by the judge on their overall impression of the run. This number is added to the score at the end of the run.

- 0-2 Average
- 3 Good
- 4 Very Good
- 5 Excellent

Obstacle scores are to be determined and assessed independently of penalty points. Penalties should be assessed per occurrence as follows:

0 – SCORE (Will be white ribbon)

1. Use of more than one finger between reins
2. Use of two hands or changing hands on reins; only one hand may be used on the reins, except that it is permissible to change hands to work an obstacle.
3. Illegal use of romal
4. Performing the obstacles incorrectly or other than in specified order
5. No attempt to perform an obstacle
6. Equipment failure that delays completion of pattern
7. Excessively or repeatedly touching the horse on the neck to lower the head
8. Fall to the ground by horse or rider
9. Failure to enter, exit or work obstacle from correct side or direction
10. Failure to work an obstacle in any manner other than how it's described by the course
11. Riding outside designated boundary marker of the arena or course area
12. Third refusal
13. Failure to demonstrate correct lead or gait, if designated
14. Failure to follow the correct line of travel within or between obstacles
15. Faults that occur on the line of travel between obstacles, which will not be cause for disqualification, but will be faulted according to severity:
  - a. head carried too low (tip of ear below the withers consistently)
  - b. over-flexing or straining neck in head carriage so the nose is carried behind the vertical consistently.

One-half (1/2) point

1. Each tick of log, pole, cone, or obstacle

One (1) point

1. Each hit, bite or stepping on a log, pole, cone, plant or obstacle
2. Incorrect gait at walk or jog for two strides or less
3. Both front or hind feet in a single-strided slot or space
4. Skipping over or failing to step into required space
5. Split pole in lope over
6. Failure to meet the correct strides on jog over and lope over log obstacles, if specified

Three (3) points

1. Break of gait at walk or jog for more than 2 strides
2. Out of lead or break of gait at lope (except when correcting an incorrect lead)
3. Knocking down an elevated pole, cone, barrel, plant obstacle, or severely disturbing an obstacle
4. Stepping outside the confines of, falling, or jumping off or out of an obstacle with one foot
5. Missing or evading a pole that is a part of a series of an obstacle with one foot

Five (5) points

1. Dropping slicker or object required to be carried on course
2. First or second cumulative refusal, balk, or attempting to evade an obstacle by shying or backing more than 2 strides away
3. Second refusal
4. Letting go of gate or dropping rope gate
5. Use of either hand to instill fear or praise
6. Stepping outside the confines of, falling, or jumping off or out of an obstacle with more than one foot
7. Blatant disobedience (kicking out, bucking, rearing, striking)
8. Holding saddle with either hand
9. Missing or evading a pole that is a part of a series of an obstacle with more than one foot

Suggested ribbons

1. 80+ Purple
2. 70-79 Blue
3. 60-69 Red
4. <59 White

## English Performance and Equitation

### English Tack

#### Bits

- An English snaffle (no shanks), Kimberwicke, Pelham, and/or full bridle (with 2 reins), all with cavesson nosebands, and plain leather brow bands, must be used.
- In regard to mouthpieces, nothing may protrude below the mouthpiece. On broken mouth-pieces only, connecting rings of 1/4 inch or less in diameter, or connecting flat bar of 3/8 to 3/4 inch (maximum length of 2 inches) and that lie flat in the horse's mouth are acceptable. Smooth round, twisted, double twisted, slow twist, straight bars, or solid mouthpieces with a maximum of a 1-inch high port are acceptable. All mouthpieces must be a minimum of 3/16 inch in diameter, snaffles to be measured 1 inch from cheek.
- English bits of any style featuring cathedral or donut mouthpieces or rough, sharp material are not acceptable.

#### Saddles

- English or forward seat skirted hunting saddles must be used.
- May have suede and/or suede insert on skirt and either cloth or leather lining.
- Girth maybe leather, web, cord or linen.

#### Optional Appointments

- Un-rowelled English-type spurs (slip-ons are acceptable), hunting breastplate and riding crops or whips are optional.

#### Prohibited Tack

- Draw reins, martingales, tie-downs, hackamores, flash nosebands, Mexican (crossed figure-8), dropped nosebands, and horse leg boots of any type are illegal during Hunt Seat Equitation, but are OPTIONAL for Equitation Over Fences.

## Hunt Seat Equitation

### Description

Hunt Seat Equitation recognizes the rider's ability to ride a horse correctly and to use various aids required for a horse to perform basic maneuvers. Riders will be judged on basic position in saddle; position and use of hands, legs and feet; ability to control and show the horse; and suitability of horse to rider. Video resource: [youtube.com/watch?v=Q9wcm886fZ8](https://www.youtube.com/watch?v=Q9wcm886fZ8)

### Class Routine:

All horses are to enter the ring at a walk, whether they enter as individuals or as a class. At all South Dakota 4-H Horse Shows, all classes will begin with individual pattern work. Additional rail work or additional pattern work is at the judge's discretion. Beginner and Junior exhibitors will be limited to the patterns in the 4-H Horse Project Show Guide. Senior exhibitors will work a pattern selected by the judge and posted to SDSU Extension website at [extension.sdstate.edu](http://extension.sdstate.edu) by July 15. Any work on the rail should include a flat-footed, four-beat walk, a two-beat trot, and a three-beat canter displaying the correct lead. Reversing, if called for, should be done away from the rail. Contestants are expected to stay on the rail at all times and the whole arena. If contestants must pass another horse, passing will take place to the inside of the ring of the horse in front.

### Tack and Attire

- Refer to English Tack on page 16 or Appendix A. For attire please refer to page 5.
- Prohibited Tack: Draw reins, martingales, hackamores, flash nosebands, crossed figure-8 nosebands, dropped nosebands and horse leg boots.

### Basic Riding Position

- The rider should sit in a comfortable, balanced, and relaxed manner while maintaining an erect upper body with eyes up and looking forward.
- The rider's legs should have a slight bend and hang beneath the rider such that when viewed from a profile, a straight line (approximately) can be drawn through the rider's ear, shoulder, hip and heel.
- The irons should be placed under the balls of the feet and not under the toe or against the heel.
- Toes should be turned only slightly out with ankles flexed in toward the horse in a comfortable position.
- The lower leg should be held such that light contact is maintained with the horse.
- Arms and hands should be held in a comfortable, relaxed manner with upper arms held in a straight line with the body. The elbow is bent such that the lower arm and hands are in a straight line to the bit.
- Hands should be slightly over and in front of the withers with knuckles 30 degrees inside the vertical.

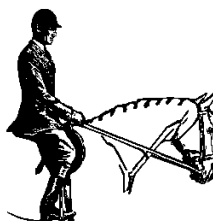

### Position in Motion

- At the walk and slow trot, body should be vertical with slight motion in the saddle.
- At a posting trot, the body should be inclined forward with slight elevation in the saddle.
- At the canter, the body should be halfway between the posting trot and the walk.
- At the gallop, and while jumping, the body should be at a similar inclination as when at a posting trot.

### Scoring and Penalties

The score sheet used for Hunt Seat Equitation for the South Dakota 4-H Horse Show can be found in Appendix C.

1. Exhibitors will be scored from 0 to 100 with 70 denoting an average score. One-half point increments are acceptable.

Maneuver scores will be indicated as follows:

- +3 Excellent
- +2 = Very Good
- +1 = Good
- 0 = Correct
- 1 = Poor
- 2 = Very Poor
- 3 = Extremely Poor

2. The Form and Effectiveness score ranges from 0 to 5. The F&E score is awarded by the judge on their overall impression of the run. This number is added to the score at the end of the run.

0-2 = Average

3 = Good

4 = Very Good

5 - Excellent

3. Faults:

a. Minor faults Three (3) point penalties

- i. Break of gait at walk or trot up to two strides
- ii. Over/under turn of  $\frac{1}{8}$  to  $\frac{1}{4}$
- iii. Tick or hit of cone
- iv. Obviously looking down to check leads or diagonals

b. Major faults Five (5) point penalty

- i. Not performing the specific gait or not stopping when called for in the pattern within 10 feet of the designated location
- ii. Missing a diagonal up to 2 strides in the pattern or on the rail
- iii. Incorrect lead or break of gait (except when correcting an incorrect lead) at the canter
- iv. Complete loss of contact between the rider's hand and the horse's mouth
- v. Break of gait at walk or trot for more than two strides
- vi. Loss of iron
- vii. Head carried too low and/or clearly behind the vertical while the horse is in motion, showing the appearance of intimidation

c. Severe faults Ten (10) point penalty

- i. Loss of rein
- ii. Missing a diagonal for more than two strides
- iii. Use of either hand to instill fear or praise while on pattern or during rail work
- iv. Holding saddle with either hand
- v. Spurring or use of crop in front of girth
- vi. Blatant disobedience including kicking, pawing, bucking and rearing

d. Disqualification (Will earn white ribbon)

- i. Failure by exhibitor to wear correct number in visible manner
- ii. Willful abuse
- iii. Excessive schooling or training
- iv. Fall by horse or rider
- v. Illegal use of hands on reins
- vi. Use of prohibited equipment
- vii. Off pattern, including: knocking over or wrong side of cone or marker; never performing designated gait, lead or diagonal; over or under turning more than  $\frac{1}{4}$  turn

e. Suggested ribbons

- i. 80+ Purple
- ii. 70-79 Blue
- iii. 60-69 Red
- iv. <59 White

## Equitation Over Fences

### Description

Equitation Over Fences is a patterned class in which contestants are evaluated on their seat, hands, and ability to control and show the hunter over fences. Emphasis shall be placed on rider's basic position in the saddle and the smoothness of performance and manners of the horse. Judges will penalize unsafe jumping and bad form over fences.

### Class Routine

There will be a minimum of four fences; horses are to make a minimum of eight jumps. At least one warm-up jump should be provided. There will be NO jump offs. Seniors are to have at least one change of direction. All hunters will be permitted to walk the official course (without horse) immediately prior to the class. Patterns for both juniors and seniors will be posted on the SDSU Extension website at [extension.sdstate.edu](http://extension.sdstate.edu) by July 15.

Note: Only exhibitors will be allowed in the ring during the final walk-through. No coaches or advisors are allowed on the course.

### Tack and Attire

- Refer to English Tack on page 16 or Appendix A. For attire, please refer to page 5.
- Optional Equipment- Protective boots or leg wraps.

### Height of Obstacles in Inches (measured from the ground to the center of jump)

| Class   | Minimum | Maximum |
|---------|---------|---------|
| Juniors | 18"     | 30"     |
| Seniors | 24"     | 36"     |

### Scoring and Penalties

The score sheet used for Equitation Over Fences for the South Dakota 4-H Horse Show can be found in Appendix C. Based on a score of 0-100, with the approximate breakdown of:

- 90-100: Excellent equitation, meets all fences squarely, keeps constant body position
- 80-89: Good performer, encounters a few minor problems with distance from fences, rider still maintains a quality ride
- 70-79: Average equitation, problems with body position or one fault on the fence due to the rider's cues
- 60-69: Poor equitation, rider lacks the correct body position, two to three fence problems, loss of trot on a trot fence
- 40-59: Severe faults, breaking to a trot on course, missed leads, loss of stirrups, drops reins
- 10-39: Rider avoids elimination, but incurs one or two refusals or knockdowns, jumps fences in a dangerous manner

### Suggested ribbons

- 80+ Purple
- 70-79 Blue
- 60-69 Red
- <59 White

### Credit

- Eyes up
- Correct body position
- Jumping fences squarely
- Good plan of attack for the course
- Release over the fences
- Working the course in a steady fashion
- Correct leads
- Lengthening and shortening strides to accommodate the fence lengths

### Faults of rider

- Loses upper body position over or between fences
- Getting ahead or behind the jump
- Incorrect stirrup positioning
- Hands not moving with the motion of the horse
- Reins not adjusted correctly
- Dropping a rein
- Rider's legs swinging with the horse
- Legs out of the proper position
- Heels up
- Hands held too straight or too flat
- Eyes down
- Wrong diagonals

- m. Inconsistent pace throughout the course
- n. Adding or excluding strides
- o. Excessive controlling of the horse through the course
- p. Poor maneuvering through the course
- q. Trot on course where it is not called for
- r. Wrong lead or counter-cantering
- s. Refusal
- t. Knockdown
- u. Blatant disobedience
- v. Unnecessary circling

**Elimination (will receive a white ribbon)**

- a. Third cumulative refusal (this is for the entire course, not each jump - i.e. three refusals at one jump will result in elimination)
- b. Jumping an obstacle before it is reset
- c. Off course
- d. Horse and/or rider falling in competition

**Knockdowns**

Knockdowns of obstacles or the cause of any portion of an obstacle, standard or wing to be knocked down by any portion of the horse, rider, or equipment will result in four faults. No penalties for touch of obstacle, standard or wing with any portion of the horse, rider or equipment. (Exception: When a horse knocks down all or any portion of an obstacle while refusing, it is not to be scored as a knockdown, but given the correct number of faults for that refusal.)

**Course Design and Distances**

Jumps should be a minimum of 48 feet apart, but all intervals must be in multiples of 12 feet (e.g. 48 feet and 60 feet apart from the point of landing to the point of take-off in the next jump). The distance from take-off or landing from the jump is usually equal to or up to 1 ½ times the height of the jump. For a jump set at 24 inches, this would be 24-36 inches from the fence. The take-off distance must be taken into consideration when spacing jumps. Ground poles or ground lines are not mandatory, however when using them, they must be placed directly below the front of the obstacle up to 3'3" out. If a ground pole is used on landing side, there must be one on the take off side. The maximum spread (width) of the ground poles, must not exceed the height of the jump. Ground lines must stay within the base of the standard. See the diagram below for legal layouts for the ground poles.

**Legal options for ground poles/ lines**  
(Note: diagram is for traveling right to left)

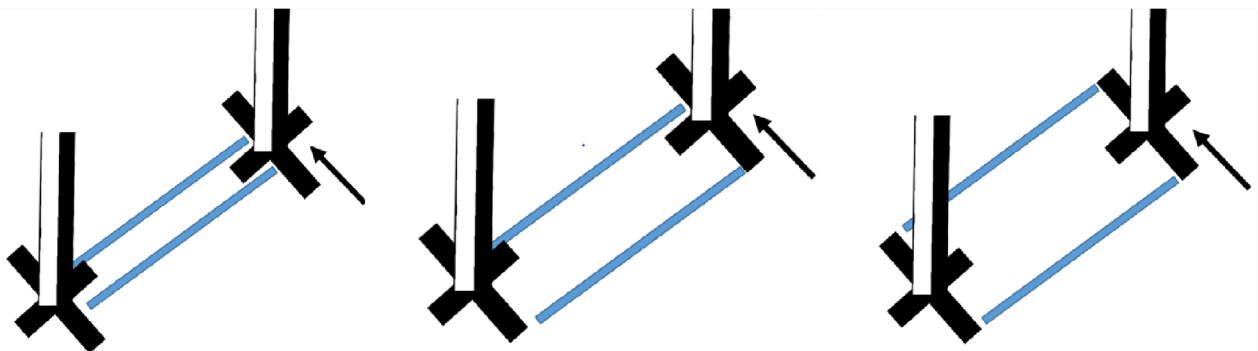

**Reinsmanship**

**Description**

Reinsmanship is an equitation class that tests the driver's knowledge of driving techniques and his/her ability to put knowledge to use to present a proficient performance. Pattern is required. Reinsmanship is judged as an equitation class based on hands, seat, correct driving technique, and proper harnessing and hitching. Driver should be able to change gaits quickly, smoothly and unobtrusively while always maintaining correct driving techniques.

Exhibitors shall compete in the reinsmanship class with their animals safely harnessed to an appropriate vehicle. One attendant must head (hold in line up) each horse. Junior exhibitors are allowed to have an adult accompany them. In the senior division, no other person is permitted in the cart while the horse is being exhibited. No pets shall be allowed in such cart during exhibition.

**Class Routine**

A single driver, horse team will enter the arena and perform the prescribed pattern. Drivers will be required to complete the pattern and the judge may call for other appropriate tests. Junior exhibitors will be limited to the patterns in the 4-H Horse Project Show Guide. Senior exhibitors will work a pattern selected by the judge and posted to the SDSU Extension website by July 15th.



### Tack and Attire

Refer to Attire on page 5.

#### Required Tack

- Cavesson noseband and blinkers are mandatory for safety purposes.

#### Vehicle

- Suitable for style of driving. Pleasure type two- or four-wheeled cart or buggy. Cart or buggy type wheels a minimum of 19-inches in diameter and with one or two seats. No stirrup type carts or sulkies may be used.
- Vehicle must be clean, safe, and in good repair.

#### Harness

- A collar or breast collar harness and standard bridle with snaffle or curb bit may be used. If curb bit is used, curb strap or curb chain must meet judge's approval and requirements as stated for Western Division.
- Harness must be safe, clean, and properly adjusted.

#### Whip

- Drivers will carry a whip in hand or in holder.

Optional: Dash and basket cover for vehicle is optional. Check reins, blinkers, breeching, martingales and cavesson nosebands are optional.

Prohibited: No wire curbs, regardless of how padded or taped, may be used.

### Basic Driving Position

- The driver must be straight in the back, sit back in the seat, the feet reaching to a foot rest with the elbows slightly forward of the body.
- Whip in hand or in the whip holder.
- The driver is usually seated on the right to access the brake at all times.

### Final Preparation

- The driver must check the hitch for appropriate adjustments for safe driving.
- The driver must achieve appropriate tension on the lines and have the whip in hand.
- The driver should know the location of the judge and the ring steward.
- An experienced driver may be on the seat beside a junior driver. If assistance is given, either via the lines, whip, or voice command the driver will be penalized.

### Gaits

- Walk - A free, regular and unconstrained walk of moderate extension is ideal. The horses should walk energetically, but calmly, with even and determined pace. The walk is a four-beat gait.
- Slow Trot - The horse should maintain forward impulsion while showing submission to the bit. This trot is slower and more collected while maintaining a steady cadence.
- Working Trot - This is a controlled lengthening of strides as the horses go forward freely and straight; engaging the hind legs with good hock action; on a taut, but light rein; the position being balanced and unconstrained. The steps should be as even as possible.
- Stop/Halt - Horses and vehicles should be brought to a complete square stop without abruptness and veering. Horse should stand attentive, motionless and straight with weight evenly distributed.
- Back - Backward movement in which the legs are raised and set down simultaneously in diagonal pairs. Back should be straight and willing.

### Scoring

- Seventy-five (75) percent on handling of reins and whip, control, posture, and overall appearance of the driver. Twenty-five (25) percent on the condition of the harness and vehicle and neatness of attire.
- Exhibitors will be scored from 0 to 100 with 70 denoting an average score. One-half point (1/2) increments are acceptable.
- Maneuver scores will be indicated as follows:
  - +3 = Excellent
  - +2 = Very Good
  - +1 = Good
  - 0 = Correct
  - 1 = Poor
  - 2 = Very Poor
  - 3 = Extremely Poor

## Draft Driving Guidelines

### Description

The Draft Horse is expected to present a picture of strength and boldness while moving forward with precision and power. There will be no passing in the show ring.

### Class Routine

Enter the ring to the right at a smooth trot. To be exhibited both ways of the ring at a smooth walk and smooth trot. No passing allowed.

### Gaits

- Smooth Walk
- Smooth Trot

### Scoring and Faults

Judging begins when the unit enters the ring. The driver will be evaluated throughout the class on posture, use of hands to gather and adjust lines, use of whip, and use and position of arms and legs. The driver's arms should be forward of the body while the horses work as a smooth consistent unit. Drivers will be evaluated on ability to command horses along the rail at a walk and trot, reverse direction, line up, stop, stand, and back. A figure eight or swing (cut) may be requested at the discretion of the judge.

The horse(s) are to be judged on performance with and suitability for the youth driver. The horse(s) must be clean, groomed, and presented in the most positive manner.

### Judge's Suggested Scoring System

|           |                       |   |
|-----------|-----------------------|---|
| 20 points | Appearance of Entry   | <ul style="list-style-type: none"><li>• Grooming (5 points)</li><li>• Condition of the animal (5 points)</li><li>• Fit of harness (5 points)</li><li>• Equipment condition/cleanliness (5 points)</li></ul> |
| 70 points | Control of the Animal | <ul style="list-style-type: none"><li>• Walk (20 points)</li><li>• Trot (20 points)</li><li>• Reverse Direction (10 points)</li><li>• Backing (10 points)</li><li>• In the lineup (10 points)</li></ul>     |
| 10 points | Driver                | <ul style="list-style-type: none"><li>• Appearance (5 points)</li><li>• Attitude (5 points)</li></ul>   |

## Team Hitch

Three divisions will be offered: miniature/pony (56 inches or less), horse, and draft. Youth may participate in only one of the divisions. Note: Youth are to indicate kind of team on Fair Entry registration; horse height will be included with the official State 4-H Horse Show entry, classes will be sorted by horse height.

A team hitch will be treated as one horse, one entry. Horses that meet the characteristics of draft breeds will be considered Draft. An adult must accompany each driver on the seat of the wagon. Restrictions on wagons apply only to the safety of other exhibitors, spectators, and horses.

### Description

Horses should be presented in a clean, thrifty, well-cared-for condition, neither thin nor excessively fat. Draft horse tails may be natural or docked, braided or left long, and should fit the proportions of the horse. Both mares and geldings are generally shown in hitch classes with their manes rolled, but this is optional. Feet may be shod or unshod, but should be properly trimmed and clean. Black or natural hoof dressing, paint, etc. is acceptable.

### Class Routine

1. Enter the ring at the walk.
2. Exhibitors will be asked to walk, trot, reverse direction, line up, and back their teams.
3. The class may include individual workouts as follows:
  - a. Line up at the end of the ring.
  - b. Work a figure eight.
  - c. Stop in front of the judge and back the team.

### Basic Driving Position

- The driver must be straight in the back, sit back in the seat, the feet reaching to a foot rest with the elbows slightly forward of the body.
- The driver is usually seated on the right to access the brake at all times.
- Enter the ring with team under control and alert.

## Class Conditions and Rules

A single team hitch (two horses harnessed side by side, one on either side of the pole) with properly adjusted hame and collar style work or show harness is required.

Always have sufficient clearance between your participant's team and the preceding wagon to stop or to turn out and pass. All passes should be made to the inside of the arena away from the rail "I" in the light horse (mini, horse) divisions. Draft hitches will not pass..

There is no passing in the Draft Horse division. Safety of your hitch and others should always be on exhibitor's mind. Exhibitor should know at what speed within each gait your team looks best. In light horse classes, exhibitors may pass a slower team rather than slow your team, but do so with care. When the ring steward asks for the reverse in direction, adequate spacing between hitches must be kept and passing must cease.

## Judge's Suggested Scoring System

|           |                       |   |
|-----------|-----------------------|---|
| 20 points | Appearance of Entry   | <ul style="list-style-type: none"><li>Grooming (5 points)</li><li>Condition of the animal (5 points)</li><li>Fit of harness (5 points)</li><li>Equipment condition/cleanliness (5 points)</li></ul> |
| 70 points | Control of the Animal | <ul style="list-style-type: none"><li>Walk (20 points)</li><li>Trot (20 points)</li><li>Reverse Direction (10 points)</li><li>Backing (10 points)</li><li>In the lineup (10 points)</li></ul>       |
| 10 points | Driver                | <ul style="list-style-type: none"><li>Appearance (5 points)</li><li>Attitude (5 points)</li></ul>   |

## Timed Performance Events

Barrel Racing, Pole Bending, Break-away Roping, Tie-down Roping, and Dally Team Roping events are included in timed performance events. If clarification of rules is needed for the Timed Performance Events, officials will refer to the South Dakota 4-H Rodeo Rules and Regulations. If further clarification is needed, officials will refer to the National High School Rodeo Association Rules, By-Laws, and Constitution.

### Barrel Racing

#### Description

The Barrel Racing Cloverleaf Pattern is designed to test the speed and maneuverability of the horse. A horse may start either to the right or left barrel then run the remainder of the pattern accordingly.

#### Class Routine

- The clover-leaf pattern is the only approved pattern in this event. See Appendix B for pattern and pattern standards.
- A clearly visible start line shall be provided.
- Two stopwatches or an electric timer with back-up watches shall be used.
- The barrels and starting line will be permanently marked for the entire go-round.
- The arena will be dragged/raked at regular intervals, to be determined by the management.
- The contestant or horse may touch the barrel.
- The contestant may not lope or gallop until the horse has reached the plane of the entry gate. No running starts allowed.
- If the gate is centrally located, the contestant must keep motion toward the arena. No spinning or circling will be allowed.
- If the gate is off-center of the pattern, a single spin or pivot is acceptable in either direction.
- Arena gate must be closed and latched immediately after the contestant enters the arena and will be kept closed until the pattern is completed and the horse is under control.
- Time will start when any portion of the horse breaks the plane of the start line. In event of a tie, a runoff will be held.

#### Tack and Attire

- Refer to Tack and Attire on pages 5-7.
- Optional: Hackamore, tie-down, gag bit, bats, crops, closed reins and protective boots.

#### Penalties

- The judge will not flag the contestant out until time is recorded. The judge is to flag time, then flag the contestant out if the run is not legal.
- Knocking over a barrel will cause an automatic five second penalty per barrel. Should the barrel be knocked over and it sets up on opposite end, the five second penalty will be assessed.
- No times (will result in white ribbon)
  - Breaking the cloverleaf pattern will result in a no time.

- A broken pattern shall be defined as breaking forward motion to retrace tracks to finish the pattern and/or passing the plane of the barrel on the off side.
  - Failure to follow the course or crossing over the start/finish line prior to completion of the pattern will be considered a broken pattern and will result in a no time.
  - Any assistant helping barrel racers will not be allowed to go past the plane of the main arena gate when they are entering the arena or the contestant will be disqualified.
  - Failure to follow gate entry requirements (i.e. circling, running in)

### **Pattern Standards**

The course must be measured exactly. The following standards should be used to set the barrel racing pattern (refer to diagram):

- Minimum of 25 yards (75 feet) between start/finish line and arena fence to allow for stopping.
- Distance between barrels 1-3 and 2-3: minimum-20 yards, maximum-35 yards.
- Distance between barrels 1-2: minimum-20 yards, maximum-30 yards.
- Minimum of 20 feet from each barrel to the fence.
- If the course is too large for the available space, the pattern shall be reduced in 5 yard increments until the pattern fits the arena. The distance from barrel #3 to the finish line need not be reduced 5 yards at a time if there is sufficient room for a horse to stop.

### **Pole Bending**

#### **Description**

Pole bending is a timed event. The pole bending pattern is to be run around six poles. A horse may start to either the right or left and then run the remainder of the pattern accordingly. Refer to Appendix B for pattern and pattern standards.

#### **Class Routine**

- A clearly visible start line shall be provided.
- Two stopwatches or an electric timer with back-up watches shall be used.
- The poles and starting line will be permanently marked for the entire go-round.
- The arena will be dragged/raked at regular intervals, to be determined by the management.
- The contestant or horse may touch the pole.
- The contestant may not lope/gallop until the horse has reached the plane of the entry gate. No running starts allowed. No spinning or circling.
- If the gate is centrally located, the contestant must keep forward motion toward the first pole.
- If the gate is off-center of the pattern, a single spin or pivot is acceptable in either direction.
- Arena gate must be closed and latched immediately after the contestant enters the arena and will be kept closed until the pattern is completed and the horse is under control.
- Time will start when any portion of the horse breaks the plane of the start/finish line.
- In the event of a tie, a runoff will be held. The horse declared the winner in the runoff must complete the pattern within two seconds of its original time or the runoff must be held again.

#### **Tack and Attire**

- Refer to Tack and Attire on pages 5-7.
- Optional: Hackamore, tie-down, gag bit, bats, crops, closed reins and protective boots.

#### **Penalties**

The judge will not flag the contestant out until time is recorded. The judge is to flag time, then flag the contestant out if the run is not legal.

- Knocking over a pole will cause an automatic five second penalty per pole.
- No times (Should result in white ribbon)
  - Breaking the pole bending pattern will result in a no time. A broken pattern shall be defined as breaking forward motion to retrace tracks to finish the pattern and/or passing the plane of the pole on the off side.
  - If a pole is knocked down and the contestant does not follow the weave pattern around the original base position of the fallen pole, it is considered a broken pattern.
  - Failure to follow the course or crossing over the start/finish line prior to completion of the pattern will be considered a broken pattern and will result in a no time.
  - Any assistant helping pole benders will not be allowed to go past the plane of the main arena gate when they are entering the arena or the contestant will be disqualified.
  - Failure to follow gate entry requirements (ie circling, running in).

### **Pattern Standards**

The pole bending pattern is run around six poles. The course must be measured exactly. The following standards should be used to set the pole bending pattern (refer to diagram):

- Minimum of 25 yards (75 feet) between start/finish line and arena fence to allow for stopping.
- The distance from the starting line to the first pole must be 21 feet.

- The poles must be spaced 21 feet apart.
- The end pole must be at least 20 feet from the fence.
- Poles must be 6 feet in height with no base larger than 14 or less than 12 inches in diameter.
- Poles must be set on top of the ground.
- Poles must be straight in line.

## Roping Events

Judge's ruling is final.

The calf or steer belongs to the contestant when he calls for it regardless of what happens, except in the case of the following:

- mechanical failure
- animal escapes from the arena

In the event of any of the above failures, the contestant will receive the original animal back with a lap-and-tap start. Time already accumulated will be added to time used to complete the qualifying run. If time is not recorded, the contestant will receive a 10-second penalty for any jump or loop used.

The catch pen gate can be open while the contestant is roping.

### Breakaway Roping

#### Description

Breakaway roping is a speed event and a variation of tie down roping in which the calf is roped, but not thrown and tied. The horse and rider wait in a box next to the chute. When the roper nods their head, the chute is opened and the calf is released. The breakaway rope is tied with a nylon string to the saddle horn. When the loop is around the calf's neck, the roper's horse stops so the weight of the calf will make the rope tight and the rope will snap off the saddle horn. The judge will drop the flag to signal end of time.

The time limit is 30 seconds. Ropers have the option of coming out of either box.

#### Tack, Attire and Equipment

- Refer to Tack and Attire on pages 5-7.
- Two loops will be allowed if two ropes are carried. The second rope must remain tied until used. Two loops cannot be thrown unless two are carried. A roper who does not carry two loops is not allowed to run again.

#### Class Routine

- Ropes must be tied to the saddle horn with nylon string tied at the knot on the rope. The rope should have a knot at the end with no tail.
- The rope may not be run through the bridle, tie down, neck rope or any other device.
- A white flag must be attached to the knot end of the rope.
- The calf's head must pass through the loop. The loop must draw down upon any part of the calf's body behind the head.
- If the field judge flags out a roper that still legally has one or more loops coming, the judge may give the same calf back, lap and tap, plus time already lapsed and any barrier penalties. If time was not recorded, the contestant will receive a 10-second penalty for any loop used. Contestant will only be granted remaining loops, not additional loops.

#### Penalties

The judge will not flag the contestant out until time is recorded. The judge is to flag time, and then flag the contestant out if the run is not legal.

The following actions will result in a no time/disqualification (Will receive white ribbon):

- Not releasing the rope from the hand when roping the calf.
- Abusive treatment of calf or horse.
- Contestant breaking the rope away from the horn by hand. \*If the rope dallies around the horn, the contestant may un-dally the rope and then stop the horse to make the rope break away. No catch or illegal catch. Failure of the calf's head to pass through loop.

### Tie Down Roping

The time limit is 30 seconds. There shall be two or more timekeepers, a tie or field judge, and as many other officials as the local management finds necessary.

#### Description

Tie down roping is a speed event in which a calf is roped, thrown and tied. The horse and rider wait in a box next to the chute. When the roper nods their head, the chute is opened and the calf is released. The roper will swing and try to get their loop around the calf's neck, the roper's horse stops and holds the calf in place for the roper to get off. Once off their horse, the roper runs down the rope, flanks and ties three legs of the calf. The judge will drop the flag to signal end of time when the roper raises their hands.

Roper must re-mount, ride forward and the calf must stay tied for 6 seconds.

#### **Tack, Attire and Equipment**

- Refer to Tack and Attire on pages 5-7.
- Required equipment: A secure neck rope, strap or rope latch.
- Two loops will be permitted if carried. Should the roper miss with both, he must retire and no time will be allowed. A contestant must adjust rope and reins in a manner that will prevent his horse from dragging the calf.

#### **Class Rules**

- Animals used for this event should be inspected and eliminated if objectionable by the judge.
- Contestant must receive no assistance after crossing starting line. If a horse drags the calf, the field judge may stop the horse and flag judge can assess any penalty for such an offense.
- Catch as catch can rule – Any catch is legal.
- The rope must be tied hard and fast.
- Contestants must dismount, follow the rope, throw the calf by hand, and cross and tie any three feet. If the calf is down when the roper reaches it, the calf must be stood on at least three feet (calf may be helped by roper, but at least three feet must dangle straight under calf) and then be re-thrown by hand. If the roper's hand is on the calf when it falls, the calf is considered thrown by hand.
- The rope must hold until the roper gets his hand on the calf.
- A legal tie requires at least one complete wrap around at least three legs and a half hitch or hooley. A hooley is a half hitch with a loop.
- A stopwatch will be used by the field judge. The calf must stay tied for six seconds and three legs must remain crossed. The judge will start timing after the roper has remounted and the horse has taken one step forward. If the rope is not on the calf when the roper begins the tie, the six-second time limit will start when the roper clears the calf. Tie must hold until passed on by judge. If the tie comes loose or the calf gets to its feet before the tie has been ruled a fair one, no time will be marked. Untie man must not touch the calf until the judge passes on the tie.
- If the field judge flags out a roper that still legally has one or more loops coming, the judge may give the same calf back, lap and tap, plus time already lapsed and any barrier penalties. If time was not recorded, the contestant will receive a 10-second penalty for any loop used. Contestant will only be granted remaining loops, not additional loops.

#### **Penalties**

The judge will not flag the contestant out until time is recorded. The judge is to flag time and then flag the contestant out if the run is not legal.

The following actions will result in a no time/disqualification (Will receive a white ribbon):

- Not releasing the rope from the hand when roping the calf.
- Abusive treatment of calf or horse, including but not limited to intentional and excessive dragging.
  - Intentional dragging is caused by the contestant.
  - Excessive dragging is defined as moving the calf more than 6 feet after the contestant has called for time.
- Touching calf, string, or rope to train horse after contestant has mounted horse. Failure of calf to stay tied for 6 seconds.
- Failure to stand calf up to be thrown.
- Failure to catch.

#### **Dally Team Roping**

##### **Description**

The time limit is 45 seconds. Penalties will be assessed after the run. There shall be two timers and a field flag judge, with the time to be taken between the two flags.

Animals used for this event should be inspected and eliminated if objectionable.

Team roping is a timed event in which two ropers, header and heeler start from boxes on either side of the chute. Once the header nods, the chute is open and the steer is released. The header ropes first and must make one of three legal head catches- around both horns, half head or around the neck. After the header catches, they turn the steer left and the heeler attempts to rope both hind legs. If the heeler only catches one, the team is given a 5-second penalty. The clock is stopped when there is no slack in the rope and ropers' horses face one another.

##### **Tack, Attire and Equipment**

- Refer to Tack and Attire on pages 5-7.
- Required Equipment: Saddle horn wrapped from base to cap with a firm material that will withstand the pressures of the dally. The horn wrap functions to provide traction to keep the dally from slipping and burning the hand or severing fingers and/or thumbs. Slick or unwrapped saddle horns are prohibited.

Each contestant is allowed to carry only one rope. No tied ropes allowed.

## Class Rules

- Header must throw the first loop at the head.
- Heeler must start from heel box.
- Time will be taken when the steer is roped and both horses are facing the steer in line with ropes dallied and tight. Each horse's front feet must be on the ground.
- Each team is allowed three total throws.
- Roper must dally to stop steer or change steer's direction.
- A 'dally' requires one complete turn around the horn.
- Both ropers must be mounted when time is taken.
- Steer must be standing up when roped by head or heels.
- No foul catches can be removed or adjusted by hand.
- If the field judge flags out a team that legally still has one or more loops remaining, the judge may give the same steer back, lap and tap, plus time already elapsed and any barrier penalties. If time was not recorded, a 10-second penalty will be assessed for each loop already thrown. Contestant will only be granted remaining loops, not additional loops.
- There will be 4 legal catches:
  - Both horns.
  - Half a head.
  - Around the neck.
  - Heeler only – Any heel catch behind both shoulders if the rope goes up the heels.

## Penalties

The judge will not flag the contestant out until time is recorded. The judge is to flag time and then flag the contestant out if the run is not legal.

- A 5-second penalty will be given for catching only one hind foot.

The following actions will result in a no time/disqualification (Will receive a white ribbon):

- Not releasing the rope from the hand when roping the steer.
- Abusive treatment of steer or horses.
- The rope is dropped or broken.
- The front foot of the steer being in the header's loop when the header dallies and switches direction.
- Heeler roping one or both front hooves in the heel loop.
- If the hooves fall out of the loop by the time the field judge drops the flag, time will be counted.
- The heeler roping the steer before it is turned and moving forward. A heel loop thrown in the switch is called a cross-fire and is illegal.
- Illegal catches:
  - Hondo passes over one horn loop over the other.
  - Loop crosses itself in the head catch (figure eight).
  - Failure to successfully head and heel animal with three allowed loops.

## **Youth In Action**

### Attire

Western or English style attire for all Youth in Action events will be acceptable. No hats allowed.

### **State 4-H Horse Youth In Action Awards**

Top three teams and top five individuals will be awarded in the State Hippology, Horse Judging, and Horse Quiz Bowl contests. In the Horse Public Speaking, Individual Demonstration, top five will be recognized. Top three will be recognized in Team Demonstrations.

### National Contest Eligibility

Only senior 4-H members age 14 to 19 (as of January 1, 2023) are allowed to participate in national competition.

National contestants representing South Dakota must be members of the South Dakota 4-H program when attending the National 4-H Event. The Western Horse Classic event is considered part of the previous year for the purpose of eligibility. Therefore the national trip earning teams and individuals from the 2023 South Dakota State 4-H Horse Show will compete at the 2024 Western Horse Classic held in Denver, Colorado in January 2024.

All participants must first qualify through the requirements listed below and meet all the state eligibility rules. States are invited to enter one (1) team of no more than four members. On teams consisting of four members, all will compete; however, the lowest score in each phase will be dropped. For those teams consisting of three members, all members' scores will count in determining individual and team awards.

- Contestants (including team alternates) may participate in only one national contest (i.e. quiz bowl, judging, hippology, etc.) per year.
- After competing in a national contest, contestants (including team alternates) are ineligible to compete in the same contest

again at the national level.

- The contestant, his or her county 4-H staff member, and the State 4-H Leader must certify as follows on the application form or an accompanying memo:  
“This contestant has not participated in post-secondary coursework in the subject area of the national competition, nor has he or she participated in training for post-secondary competition in the subject area of the national 4-H competition.” The following competitive events are available for senior 4-H members:
  - National 4-H Hippology Contest – Top four senior individuals will be eligible to represent South Dakota at the Western National 4-H Roundup in Denver, Colorado. In the event one of the top four senior individuals are unable to attend, they will be replaced with a national eligible member at the discretion of the State 4-H Office and the Horse Committee Chair. Preference will go to next high point individual senior.
  - National 4-H Horse Judging – Top four individual senior horse judges will be eligible to represent South Dakota at the Western National 4-H Roundup in Denver, Colorado. In the event one of the top four senior individuals are unable to attend, they will be replaced with a national eligible member at the discretion of the State 4-H Office and the Horse Committee Chair. Preference will go to next high point individual senior.
  - National 4-H Horse Quiz Bowl – Top Horse Quiz Bowl team will be eligible to represent South Dakota at the Western National 4-H Roundup in Denver. In the event that a contestant can't attend the national contest or the top team included a Junior age member, they will be replaced with a national eligible member at the discretion of the State 4-H Office and the State 4-H Horse Committee. Preference will go to next high point individual senior.
  - National 4-H Public Speaking Contest – Top Senior receiving a purple in public speaking at the State 4-H Horse Show will be eligible to represent South Dakota at the Western National 4-H Roundup in Denver, Colorado.
  - National 4-H Individual Demonstration Contest - Top Senior receiving a purple in individual demonstration at the State 4-H Horse Show will be eligible to represent South Dakota at the Western National 4-H Roundup in Denver, Colorado.
  - National 4-H Team Demonstration Contest - Top Senior Team receiving a purple in team demonstration at the State 4-H Horse Show will be eligible to represent South Dakota at the Western National 4-H Roundup in Denver, Colorado.

South Dakota 4-H makes no guarantees or provisions regarding the existence of or South Dakota 4-H's participation in any national 4-H contest.

### **State 4-H Hippology Contest**

Hippology is an activity that can make learning fun for 4-H members by letting them exhibit their knowledge and understanding of equine science and husbandry in a friendly but competitive setting.

#### **Teams and Contestants**

- Each team must consist of no less than three and no more than four members. Reminder: Only Senior contestants will be eligible for National Competition.
- Junior and Beginner members are not eligible to attend the National Contest.
- Contestants (including team alternates) that have participated in the Hippology National Contest may only compete as individuals in the State Hippology Contest.
- Teams must be identified by a county office by July 15th to the State 4-H Office by emailing team to [sdsu.4h@sdstate.edu](mailto:sdsu.4h@sdstate.edu).

#### **The Contest (4 Phases)**

Examination Phase – may include but not limited to:

- Written Exam
- Projected slides to be identified as to breed, color, color pattern, activity, proper appointments, etc.
- Anatomy which may include external, skeleton, internal organs, parts of gastrointestinal tract, male and female reproductive organs, detailed anatomy of the foot and detailed lower limbs.

Station Phase – this phase will consist of a series of stations, tables or projected slides where all contestants will respond to the requirements of the station. Members will be allowed two and a half minutes at each station. Examples of stations which may be used but not limited to:

- Identification of:
  - Various types of saddles (actual or pictures) and parts of saddles.
  - Tacks, bits, bridles, horse shoes and parts of shoes. Tools and equipment, and assembly of specific parts of various pieces of equipment. Grains and forages used in equine rations including various forms of methods of preparation.
  - Internal and external parasites based on actual samples, pictures, life cycle charts and /or damage caused.
  - Blemishes and unsoundnesses.
  - Age of equines based on teeth.
  - Use of pulse rate, respiration rate, temperature, dehydration, anemia, etc., to assess horse health.
  - Measurements such as, but not limited to, wither height, shoe size, girth, collar size, gullet width, seat length of saddle, etc. may be required.

Judging Phase – contestants will be required to place at least two classes.



Team Problems Phase – Each team will be presented with the same problem(s). They will have equal time to discuss among themselves the problem, immediately after which they will have to present an oral solution or series of suggested procedures relative to the problem.

Each team member is encouraged to participate in the oral presentation. Evaluation will be based on the understanding of the problem, completeness of the response, the probability of success of the solution or procedures, and the logic used in making the oral response.

The official may ask questions of any or all of the team members to clarify the presentation. Team problem scores will not be included in determining the rank of individuals but will be added to the team scores from the other three phases to determine overall team standings. Examples of possible team problems include but are not limited to:

- Balancing a horse's ration.
- Farm management recommendations for specific horse operations (i.e. breeding, training, boarding, nursery, lay-up, etc.)
- Considerations for the establishment of a new horse facility (stable to be used for a specific purpose).
- Recommendations for selecting, locating, and purchasing horses for specific uses.
- Behavior problems—causes, management of and corrections.
- Training and conditioning programs—equipment, schedules, methods, nutrition, and problem avoidance.
- Breeding and /or leasing contracts—specific clauses for insurance, liability, payments, care, termination, transport, etc.
- Teaching lessons in horse management (specific subject to be announced) to a group of 9 -11 year old beginner participants: where, how long, how much information, hands- on experience, reinforcement, testing evaluation, will be considered.
- Explanation of use or assembly of specific equipment.
- Demonstrate skill or ability to use specific equipment.

### **Tie Breaking**

All ties overall, individual and team, will be broken using the following sequence:

1. Examination score
2. Overall Station score
3. Cumulative Judging scores
4. Station scores, in order

### **Resources**

- *IDET Illustrated Dictionary of Equine Terms* - New Horizons Equine Education Center. Alpine Publications, PO Box 7027, Loveland, CO 80537 Phone: (800) 777-7257
- *Evans The Horse* - Evans, Borton, Hintz, and Van Vleck. Second Edition. W. H. Freeman and Company, 660 Market Street, San Francisco, CA 94104 Phone: (415) 391-5870
- *Lewis Feeding and Care of the Horse* - Lon Lewis Williams and Wilkins. Second Edition. 351 West Camden Street, Baltimore, MD 21201-2436 Phone: (800) 638-0672
- *HIH Horse Industry Handbooks and updates* - American Youth Horse Council; 1 Gainer Rd, McDonald, NM 88262 Email: [info@ayhc.com](mailto:info@ayhc.com) Phone: 817.320.2005 Web: <http://www.ayhc.com/shop>
- *HS Horse Smarts* - American Youth Horse Council; 1 Gainer Rd, McDonald, NM 88262 (available spring 2017) Email: [info@ayhc.com](mailto:info@ayhc.com) Phone: 817.320.2005 Web: <http://www.ayhc.com/shop>
- *AQHA AQHA Rulebook: 2017* 65th edition <http://aqha.com/handbook> Only show rules will be used (SHW300-SHW712).
- *Parker Equine Science* – Rick Parker. Fourth edition. ISBN-13: 9781111138776; Published January 2012
- Grains, forages, and feed preparations used in this contest will be representative of feeds utilized in horse rations.

### **State 4-H Horse Judging Contest**

Horse judging provides a foundation for training, buying, selling and producing high quality horses. It is the base for developing qualified judges all while promoting decision making skills, public speaking and self confidence.

### **Teams and Contestants**

- Teams consist of three to no more than four members.
- Only Senior contestants are eligible for the National Horse Judging Contest.
- Individuals who have competed in the National Horse Judging contest can judge at the South Dakota State 4-H Horse Judging Contest. They must meet the entry deadline.
- An unlimited number of youth from a county can judge at the South Dakota State 4-H Horse Judging Contest. They must meet entry deadline; no late entries will be accepted.
- It is the responsibility of the 4-H Youth Program Advisor or coaches to verify team and individuals by July 15.
- Team member names must be submitted by a county office to the State 4-H Office by email to [sdsu.4h@sdstate.edu](mailto:sdsu.4h@sdstate.edu).

### **The Contest**

The State 4-H Horse Judging Contest will be comprised of halter classes and performance classes. Youth will be given 12 minutes for halter classes, 2 minutes on each profile, front and rear view. The horses will travel at walk and trot, then a 1 minute close inspection. Halter classes will be judged on the priorities of balance, muscle, structural correctness and quality. Performance class

options are: Western Pleasure, Western Horsemanship, Trail, Reining, Ranch Riding, Hunter Under Saddle, Hunt Seat Equitation and Hunter Hack.

Beginners will judge 2 halter classes, answer one set of questions and have a 25 point parts identification. Juniors will judge 4 classes, have one questions class and give one set of oral reasons. Two separate classes must be used for reasons and questions. Seniors will judge 4 classes, have one set of questions and give two sets of oral reasons- one halter and one performance. Separate classes must be used for reasons and questions. Scantrons will be used. During the contest, no cell phones, no talking or no outside assistance will be allowed.

### **Scoring**

A correct placing will receive a score of 50 points.

Points are deducted from 50 for placings which differ from the official placing. The deduction will be based on the difference between animals being judged or cuts. Cuts will be assigned to each pair within the class. Small cuts indicate the animals being compared are similar, with large cuts denoting a more distinct difference. The sum of the three cuts can not be over 15 points.

### **Tie Breaker**

In the event of a tie, the following will be used:

- Highest total reasons score, if applicable
- Lower reasons class placing, if applicable
- Total overall placing
- Highest single reasons.

### **State 4-H Horse Quiz Bowl**

The objectives of this contest are to stimulate learning and provide an opportunity for youth to demonstrate their knowledge of equine-related subject matter in a competitive setting with attitudes of friendliness and fairness. The contest will provide an educational experience for both participants and spectators. The contest is open to all 4-H members, including those who may not own a horse. The South Dakota 4-H Horse Quiz Bowl competition will follow the National Contest process and procedures.

### **Teams**

- To participate in the South Dakota State 4-H Horse Quiz Bowl Contest, the participant should be a current 4-H member. Reminder: Only Senior contestants will be eligible for National Competition.
- Contestants that have participated in the National Quiz Bowl contest are not eligible to compete in the South Dakota State 4-H Quiz Bowl Contest.
- A team must consist of no less than three and no more than five members. Teams with only three (3) members will not be eligible to answer during the fourth and eighth question during the one-on-one questions designated for the fourth chair. Or be eligible for the team bonus for all four members answering a question.
- Senior teams should be made up of only Seniors. Junior members are not eligible to attend the National Contest. If junior members are on the state championship team, they will be replaced with national eligible members at the discretion of the State 4-H Office and State 4-H Horse Committee. Preference will go to next high point individual senior. Teams must be identified by July 15th to the State 4-H Office by email to [sdsu.4h@sdstate.edu](mailto:sdsu.4h@sdstate.edu).

### **The Contest**

Only 4 contestants may be seated on the panel at any one time. One team member may be replaced on the panel when:

- The moderator deems it impossible for one of the seated members of the team to continue in the contest.
- The captain or coach of a team requests the replacement of a team member.
- The removed team member may not return to that particular match.

There may be only one coach designated during any given round. The coach and alternate of a team should sit in the designated area. Coaches will not be allowed in the holding room during rounds. The State 4-H Quiz Bowl Contest will be double elimination.

### **Questions**

There will be three types used:

- One-On-One questions to which individual contestants may respond. These points will count toward individual and team scores.
- Toss-Up questions are open to response by all contestants. These points will count toward individual and team scores. Three toss-up questions will have a bonus question attached and in general will be somewhat more difficult.
- Bonus questions are given to the team whose member has just correctly answered a toss-up question. The team is given 10 seconds to confer on this question which usually has more than one part. All parts of the bonus question must be answered before any points will be awarded. These points will count toward a team score. Only one member of the team will answer, however other team members may feed information to the individual answering.

### **Match Procedures**

NOTE: The number of questions will decrease at the South Dakota State 4-H Horse Quiz Bowl Contest due to time constraints. All

other rules will follow National Quiz Bowl Guidelines.

- Each match will be divided into two parts based on number of questions (20 questions per round plus 3 bonus questions).
- In the first part of the match, during the one-on-one competition, only one member of each team will be eligible to respond to a question. This eligibility will rotate with each question beginning with the number 1 players on each team, and passing to the number 2, 3 and 4 contestants of each team, respectively, until all the one-on-one questions have been asked. The number of questions asked during the first part of the game should be evenly divisible by 4 to assure each team member an opportunity to respond to the same number of questions (i.e. 8 questions).
- During the second part of the match any individual on either team may respond to a question (12 total questions).
- After being recognized by the moderator, the contestant activating the buzzer shall have five (5) seconds to begin the answer to the question. If the buzzer is activated during the reading of any question, the moderator immediately will cease reading the question.
- The moderator will continue reading questions (and bonus questions if applicable) until all questions have been asked.
- If a question is thrown out either due to poor reading by the moderator or a decision of the referee judges, it will be replaced by another question so that the total number of questions to be asked remains consistent.
- Either team captain or coach, or the moderator may call for a “time out” for clarification of a rule, to permit replacement of a team member, or to allow for unexpected problems. These “time outs” may be called only after a question has been answered and before the start of the next question.
- The protest of a question or answer to a question may be made only by a team captain or coach and then only at the time a particular question is read or the answer is given. The moderator and the referee judges will consider the protest, and their decision in all cases is final.

**Resources**

- *Illustrated Dictionary of Equine Terms* – New Horizons Equine Education Center. Alpine Publications.
- *The Horse*, 2nd Edition – Evan, Borton, Hintz, and VanVleck. W.H. Freeman and Company.
- *Feeding and Care of the Horse*, 2nd Edition – Lon Lewis. Williams and Wilkins.
- *Horse Industry Handbook* – American Youth Horse Council; PRIMEDIA Equine
- *Horse Smarts* – American Youth Horse Council
- *AQHA Handbook*, 70th Edition – Only show rules will be used, SHW300-SHW750. [www.aqha.com/handbook](http://www.aqha.com/handbook)
- *Equine Science*, 4th Edition – Rick Parker

**Top Individual Scoring**

Only those contestants who have participated in three or more matches at the State contest will be considered for the top individual awards. The three high match scores for each individual will be used in cases where individuals participate in more than three matches. Ties for individual awards will be broken on the basis of: first, high average score for the entire contest; second, high individual match scores; and third, total number of points earned.

**Quiz Bowl Scoring System**

|   | <b>Correct</b>   | <b>Incorrect</b> |
|---|--|------------------|
| One-on-One Questions  | + 2 points   | -1 point         |
|   | Contestant other than the two designated contestants responds: -2 points |                  |
| Toss-up Questions   | +1 point   | -1 point         |
| Bonus Questions   | +3 points  | No deduction     |
| Failure to signal or contestant not acknowledged by moderator |  | -1 point         |
| Protest not upheld  |  | -1 point         |

**State 4-H Horse Public Speaking Contest**

**Contest Rules**

- The subject matter must pertain to the horse industry. Speeches not appropriately related to the horse industry can be disqualified at the discretion of the judge(s).
- No visual aids may be used, including the use of handouts such as bibliographies and pamphlets. Contestants will be disqualified for using any visual aid, including handouts, prior to, during, or after the speech.
- Contestants may use notes. However, excessive use of notes may be counted against the contestant. This will be at the discretion of the judges.
- A public address system will not be used, but a podium will be provided.
- During the competition the contestants may introduce themselves by name, state, and speech title.
- Speeches should be 7-10 minutes in length. One point will be deducted from the total score for each minute or fraction of a minute under 7 minutes or over 10 minutes by each of three judges for a three points per minute total deduction. After the individual has been introduced by the superintendent, the time will start once the contestant begins to speak.

- Contestants should cite their major reference materials at the end of the presentations. This time will not be counted in the allotted time.
- Only the judge(s) may ask questions of the contestant. Question time will not be counted in the allotted time. Contestant should repeat the question then answer it.
- Contestants will sign up for a time to give their presentations when registering for State Horse Show on FairEntry.
- Ties will be broken by:
  - first the judges accumulated delivery score
  - second the judges accumulated organization score
  - third on content and accuracy scores
- For educational purposes the management may videotape all speeches with individual consent.

#### **Judge's Suggested Scoring System**

See Score sheet in Appendix C.

#### **State 4-H Horse Demonstration Contest**

##### **Individual and Team Contest Rules**

- The subject matter must pertain to the horse industry. Demonstrations or presentations not appropriately related to the horse industry can be disqualified at the discretion of the judge(s).
- Presentations may be either of demonstration or illustrated talk format. No live animals may be used.
- Contestants may use notes. However, excessive use of notes may be counted against the contestant. This will be at the discretion of the judges.
- A public address system will not be used in the contest. In order to alleviate technology issues and provide smooth transition between each presenter, youth are REQUIRED to bring their digital presentation on a USB flash drive. Internet access is not a guarantee nor is access to online cloud sharing platforms (i.e. Box, iCloud, Google Drive, etc.).
- Creative audio visual aids may be used, but the contestants must be involved in making or designing them.
- During the competition, the contestants may introduce themselves by name, state and presentation topic.
- Presentations should be 10-15 minutes in length. One point will be deducted from the total score for each minute or fraction of a minute under 10 minutes or over 15 minutes by each of three judges, for a three-points per minute total deduction. After the individual or team has been introduced by the superintendent, the time will start once the contestant(s) begin(s) to speak.
- Contestants should cite their major reference materials at the end of the presentation. This time will not be counted in the allotted time.
- Only the judge(s) may ask questions of the contestant. Question time will not be counted in the allotted time. Contestant should repeat the question, then answer it.
- Contestant will sign up for a time to give their demonstration when registering for State Horse Show on FairEntry.
- For educational purposes the presentations may be video recorded with individual or team consent.
- Once an individual or team has started the demonstration (in this case it is after they have been introduced by the superintendent), they may not receive assistance from any coach, parent, audience member, or other person, which includes, but is not limited to, the stroking of any key on a computer or other audio visual device. The penalty for violating this rule is disqualification.
- Ties will be broken by:
  - first the judges' accumulated delivery score
  - second by the judges' accumulated organization score
  - third on content and accuracy scores

#### **Scoring**

See score sheet in Appendix C

## Premier Horse Exhibitor

South Dakota 4-H launched the Premier Horse Exhibitor in 2022. This award recognizes a more comprehensive development of the horse project knowledge. The premise of the award mirrors the three points of the 4-H Livestock Management Triangle.

There will be one award for each of the three 4-H age divisions (beginner, junior, senior). The awards will be presented at 2023 South Dakota State Fair awards ceremony.

### Scoring Matrix

The scores for the Premier Horse Exhibitor Award will be determined by the qualifying events at State Horse Show. Each event contributes one third of overall score. Maximum score is 300 points.

| Award                       | Highest Showmanship Score | Hippology/Horse Judging Score  | Event Score (Highest score other than showmanship) |
|-----------------------------|---------------------------|--|--|
| 1st Overall in Age Division | 100                       | Uses 50 possible points from the station and test portions of the contest for a possible 100 points total. |  |
| 2nd Overall in Age Division | 97                        |  |  |
| 3rd Overall in Age Division | 94                        |  |  |
| 4th Overall in Age Division | 91                        |  |  |
| 5th Overall in Age Division | 88                        |  |  |
| Purple Ribbon               | 85                        |  | 100  |
| Blue Ribbon                 | 80                        |  | 95   |
| Red Ribbon                  | 75                        |  | 90   |
| White Ribbon                | 70                        |  | 85   |









If a youth shows in both English and Western Showmanship, the highest score prevails. Youth cannot gain more than 100 points per matrix column.

Tie Breakers:



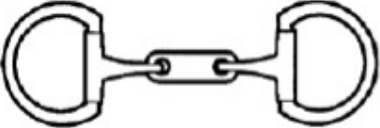
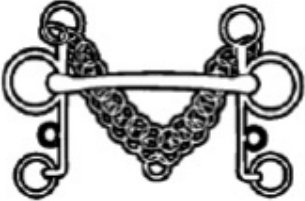
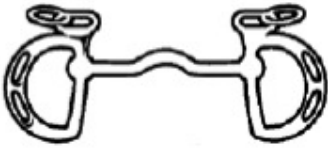
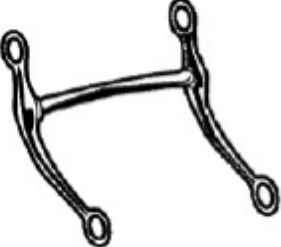

- Showmanship
- Hippology – Event
- Coin toss

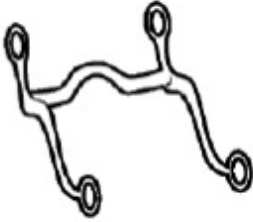
# APPENDIX A

## Legal and Illegal Tack

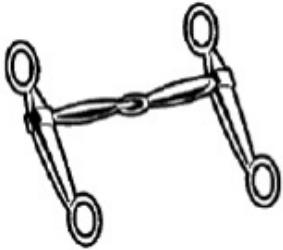
|   |   |  |
|---|---|--|
|    |   |             |
| <p>1. Gag Snaffle – Verify chain ok on time. Must meet mouthpiece standards.</p>    | <p>2. Double twisted wire – legal in English classes only.</p>                      | <p>3. Single twisted wire – legal in English classes only – must meet mouthpiece standards</p> |
|    |   |             |
| <p>4. Legal D-ring snaffle</p>  | <p>5. Legal O-ring snaffle</p>  | <p>6. Slow twist – legal in English classes only.</p>  |
|    |   |             |
| <p>7. Legal snaffle – flat piece must meet standards.</p>                           | <p>8. Pelham with mullen mouth – legal English bit.</p>                             | <p>9. Legal kimberwick – (English bits).</p>   |
|  |  |           |
| <p>10. Legal curb with mullen mouth (shanks 8 inches or less).</p>                  | <p>11. Legal curb with low port and 8 inches shanks.</p>                            | <p>12. Legal curb.</p>   |

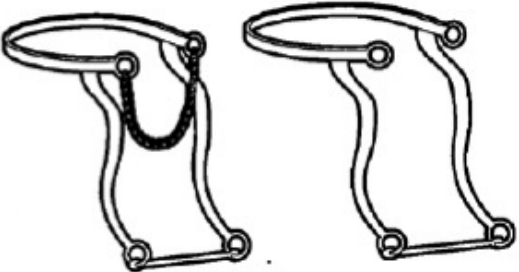
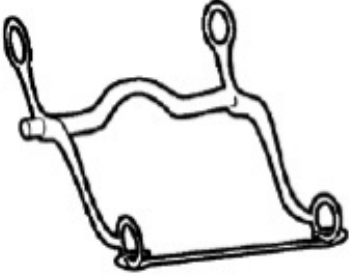
## Legal and Illegal Tack

|   |   |  |
|---|---|--|
|  |  |    |
| <p>13. Legal curb with broken mouthpiece.</p>                                     | <p>14. Legal curb with roller and 8 inches shanks.</p>                            | <p>15. Legal hackamores for speed events (and roping) only. Any wire or chain must be flat and leather or latex covered.</p> |
|  |  |   |
| <p>16. Illegal curbs - shanks 9 inches long.</p>                                  | <p>17. Legal curb with broken mouthpiece.</p>                                     | <p>18. Illegal donut bit.</p>  |



**Examples of Legal Curb Chains and Straps  
(except in barrel racing, pole bending, roping)**

Double link, flat chain – over 1/2-inch wide leather end straps

Double link, flat chain – over 1/2-inch wide nylon end straps

Double welded chain – over 1/2-inch wide

Very wide, flattened chain links – Hunt and Polo

Flat nylon – over 1/2-inch wide

Flat leather over 1/2-inch wide

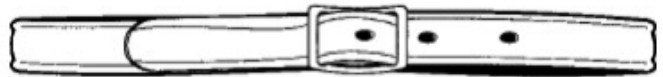
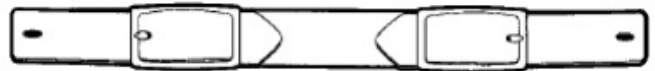
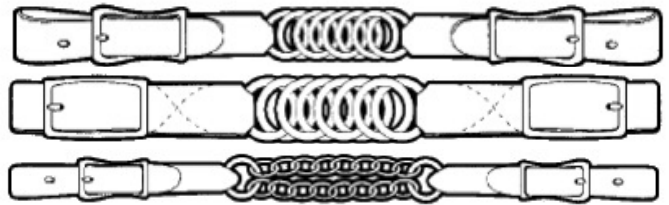

**Examples of Illegal Curb Chains and Straps**

Double link, flat chain – under 1/2-inch wide nylon end straps

Round leather, too narrow, rounded

Round leather, too narrow at chin and rounded



## Legal English Nosebands

Cavesson noseband

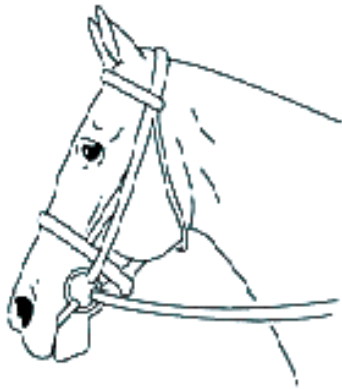

## Illegal English Nosebands

Dropped noseband

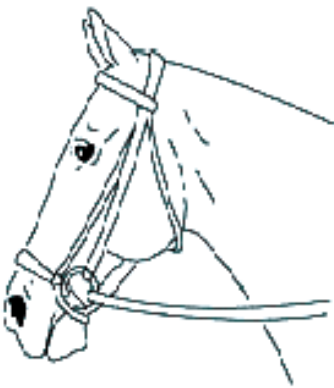

Flashed noseband

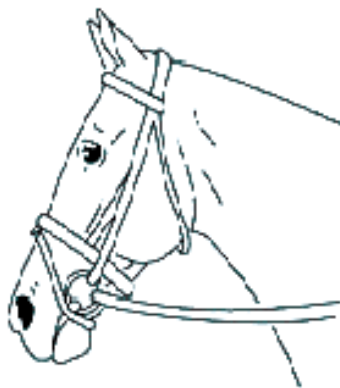

Mexican (crossed figure-8) noseband

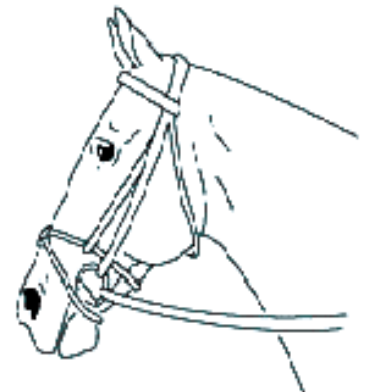

# **APPENDIX B**

---

## Patterns

**For classes with a pattern, beginners and juniors will use the patterns listed in this appendix. Senior patterns will be posted to SDSU Extension website by July 15.**

# Barrel Racing Course

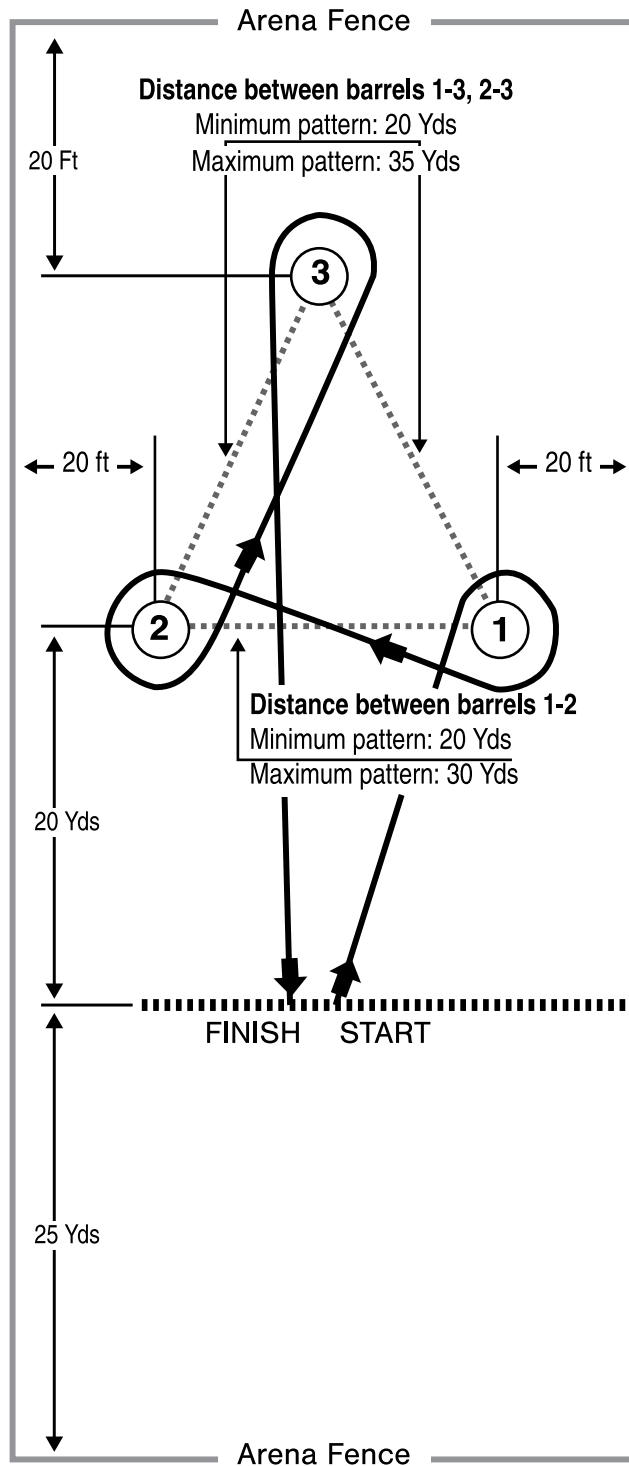

Pole Bending

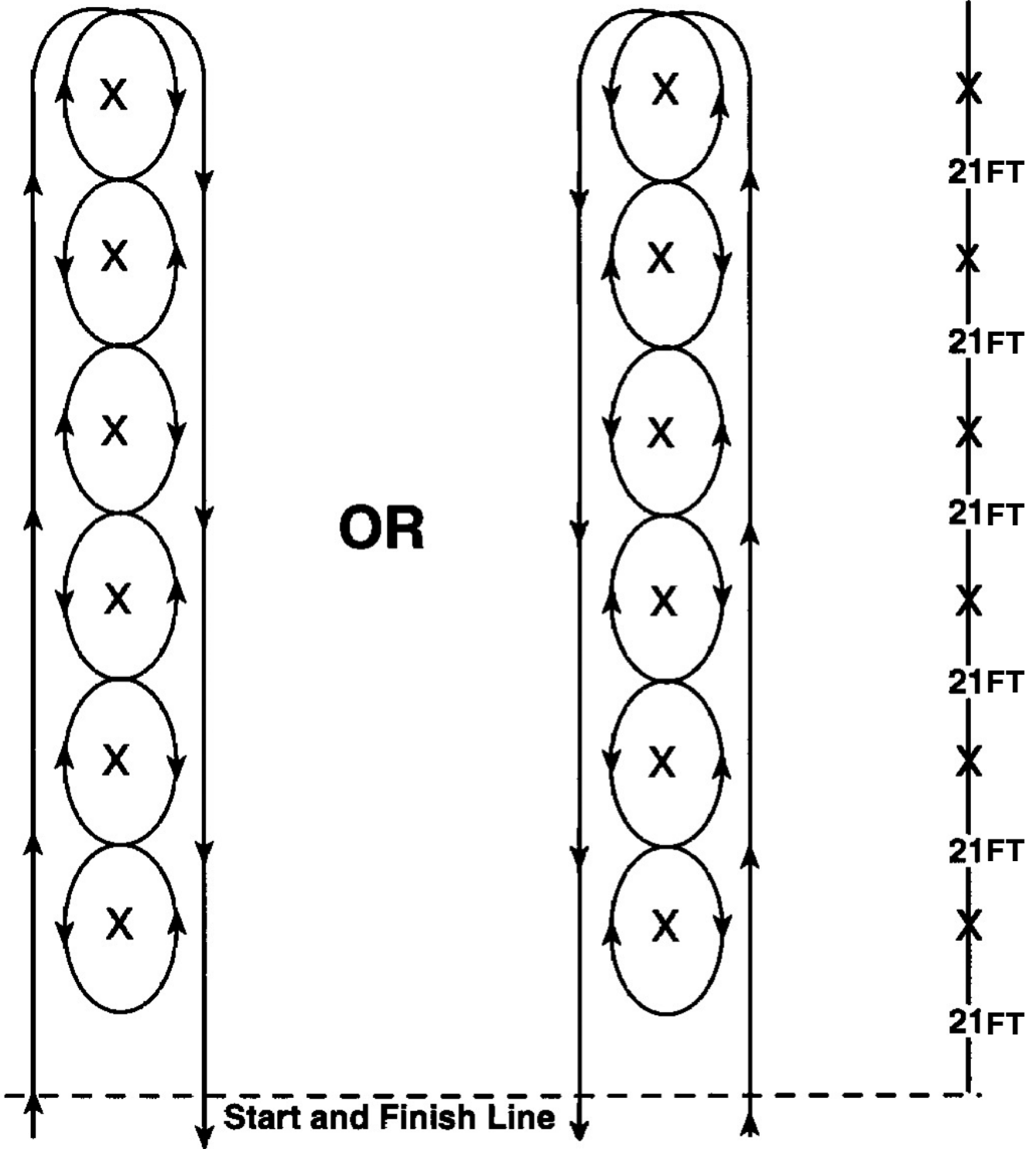

## Beginner/Junior Draft Horse Showmanship Pattern 1

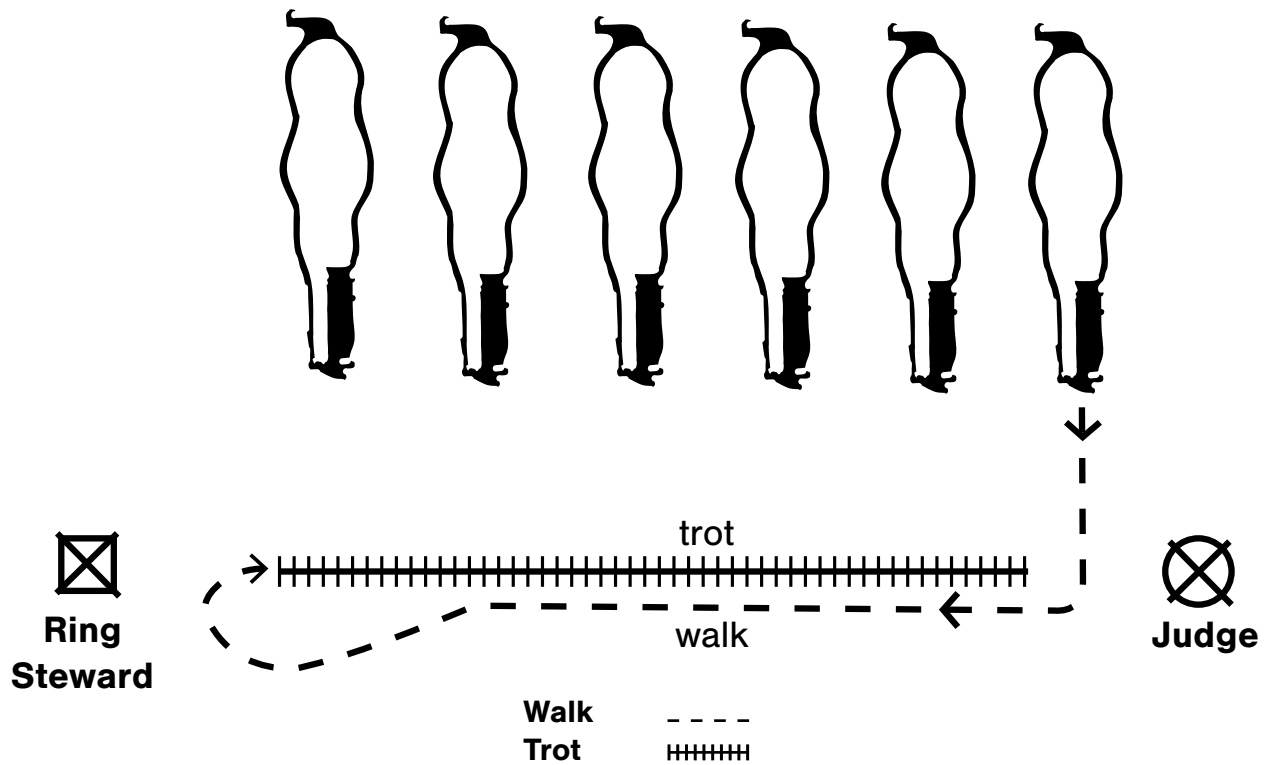

Horses will enter the ring at the trot and line up side-by-side at the direction of the ring steward.

1. From the line, walk from the ring steward to the judge (vise versa).
2. Turn horse in arc to the right
3. Trot back to starting point.
4. Stop and set up for inspection.
5. Once dismissed, return to line.

## Junior Draft Horse Showmanship Pattern 2

Produced by Horse Show Patterns.com

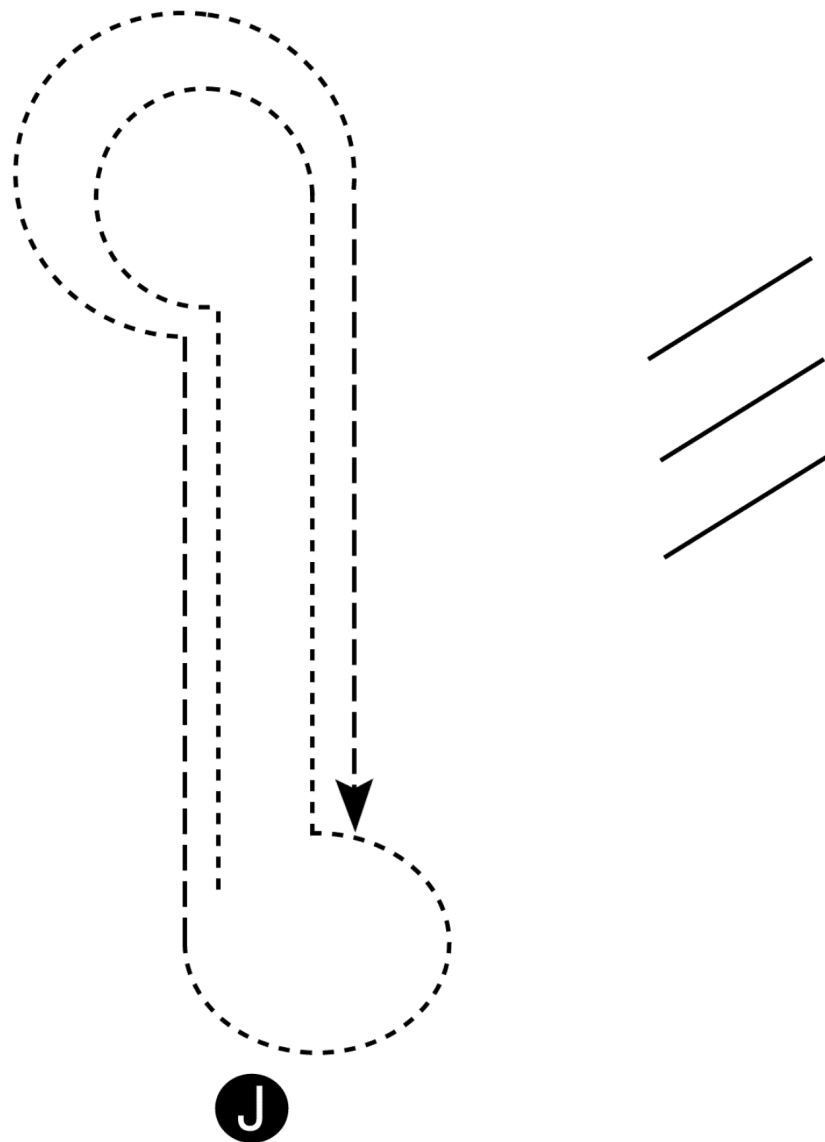

1. From Judge, walk straight away. Walk a “golf club” loop and continue walking towards Judge.
2. Make a “golf club” loop at a walk. When lined up with Judge, trot in a straight line away from Judge.
3. Walk a “golf club” loop and trot the remainder of the way back to the Judge. Set up for inspection (may turn horse 45 degrees either direction.)
4. When dismissed, trot away from Judge.

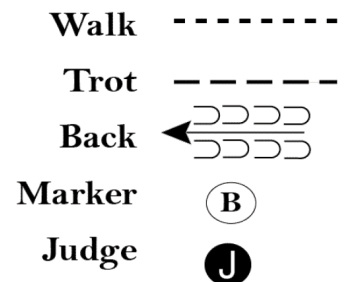

## Western/English Showmanship Beginner Pattern

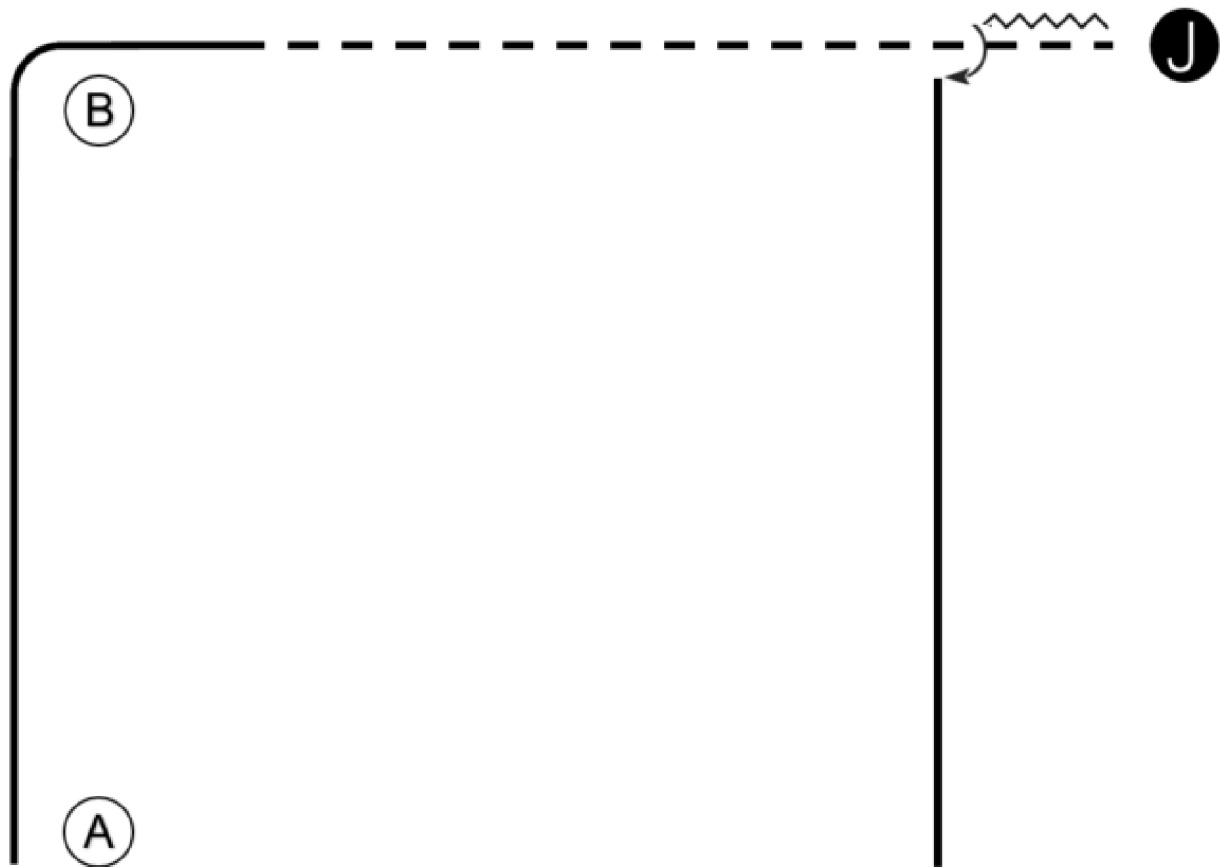

Be ready at A.

1. Walk to and around B.
2. Pick up trot and trot to judge.
3. Stop, set up for inspection, inspection
4. When dismissed, back one (1) horse length
5. Perform a 90° turn to right
6. Walk to line up or exit the arena.



# Western/English Showmanship Junior Pattern Option 1

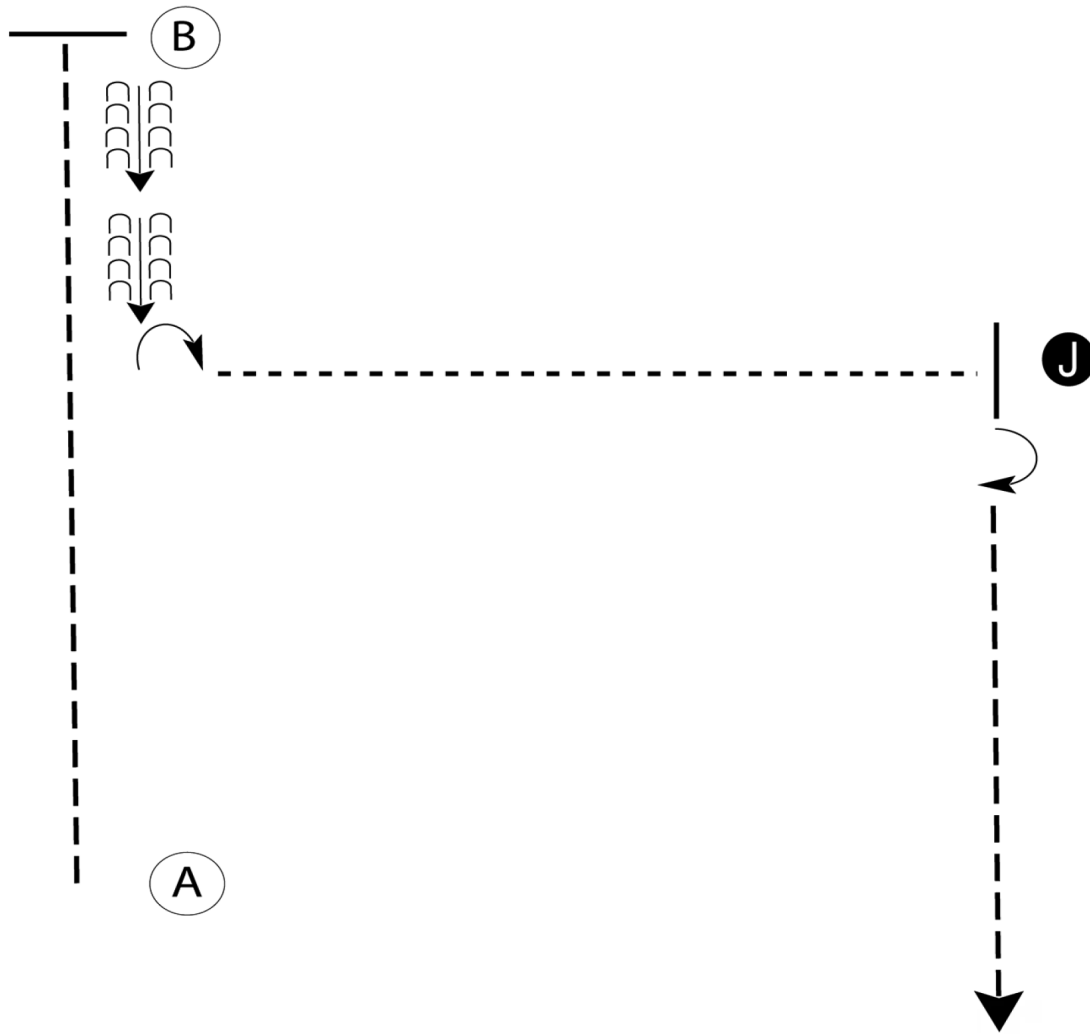

Be ready at A.

1. Trot to B and stop.
2. Back until even with judge.
3. Perform a 90 degree turn. Walk to judge.
4. Stop, set up, inspection.
5. When dismissed, perform a 90 degree turn.
6. Trot to the line up or follow the directions of the ring steward.

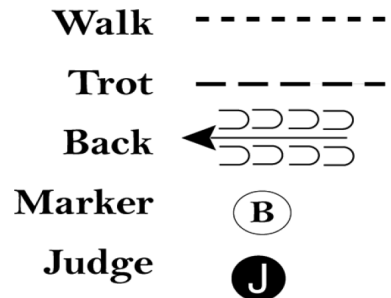

## Western/English Showmanship Junior Pattern Option 2

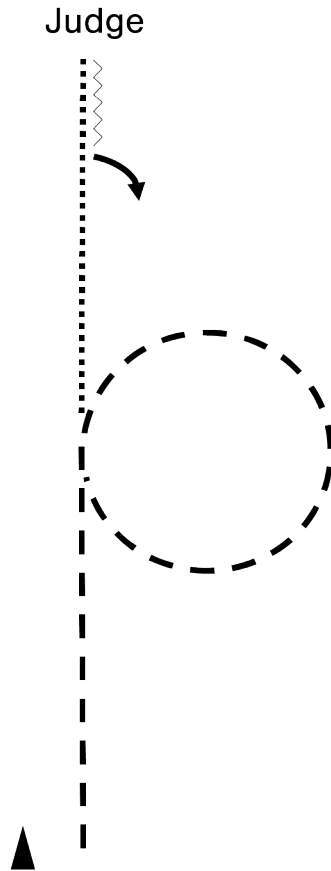

1. Be ready at cone.
2. Trot a straight line.
3. When halfway to judge, trot a circle to the right.
4. When circle is complete, walk straight line to judge.
5. Inspection.
6. Follow the directions of ring steward.
7. When dismissed, back one (1) horse length.
8. Perform a 90° turn to right.
9. Walk to line up or exit the arena.

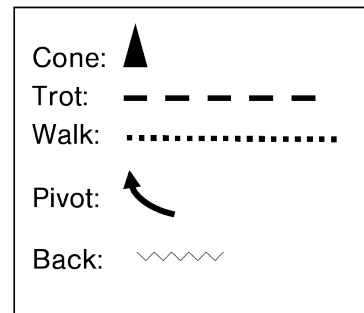

# Hunt Seat Equitation Beginner Pattern

Produced by Horse Show Patterns.com

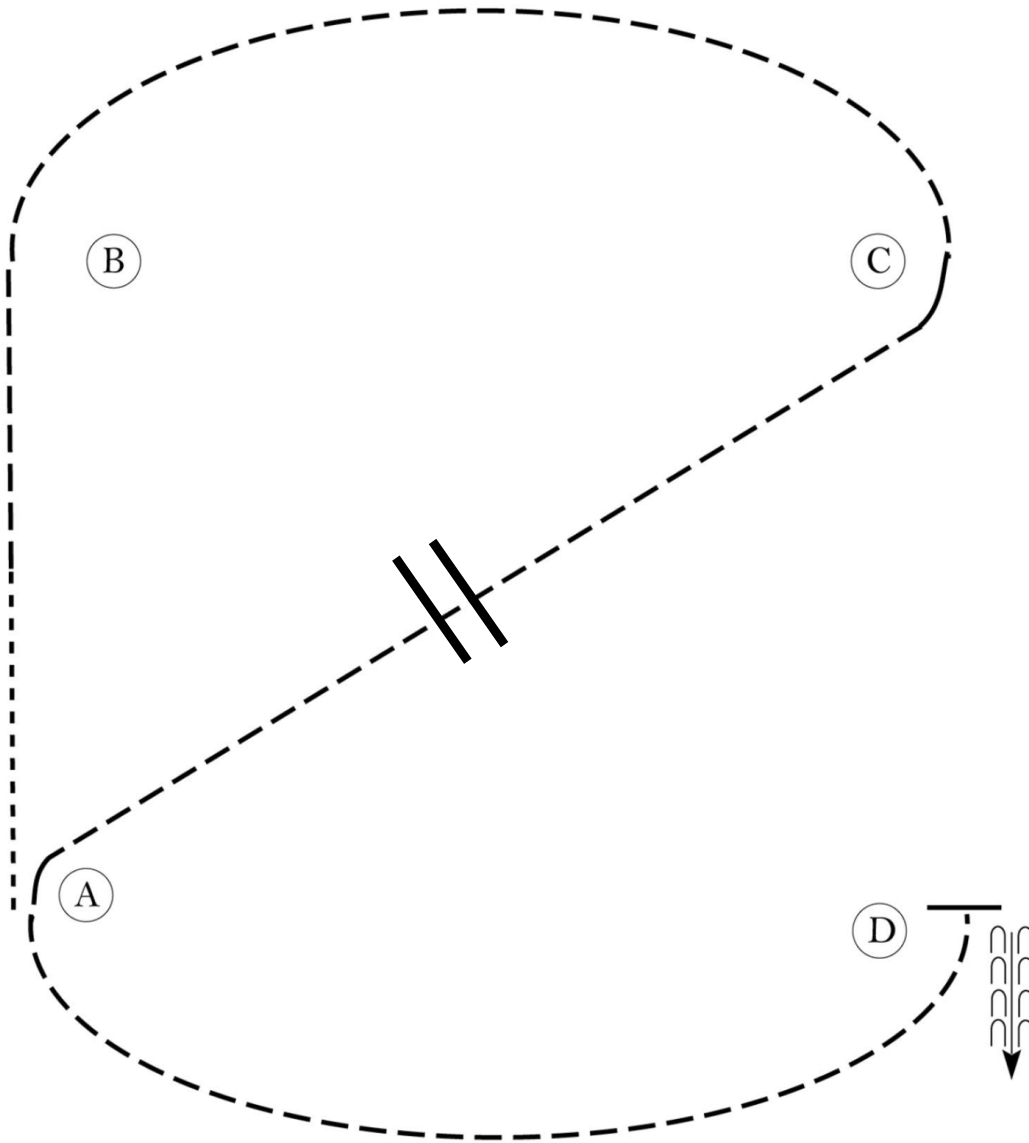

Be ready at A.

1. Walk halfway to B.
2. Sitting trot to B.
3. Trot on left diagonal from B, to and around C, and halfway to A.
4. Change diagonals halfway to A.
5. Trot on the right diagonal around A and to D.
6. Stop at D and back approximately one horse length.

Walk off and follow the directions of ring steward.

|                 |       |
|-----------------|-------|
| Walk            | ----- |
| Trot            | ----- |
| Extended Trot   | ----- |
| Canter          | ----- |
| Lead Change     |       |
| Back            |       |
| Cone            |       |
| Hand Gallop     | ----- |
| Diagonal Change |       |

## Hunt Seat Equitation Junior Pattern Option 1

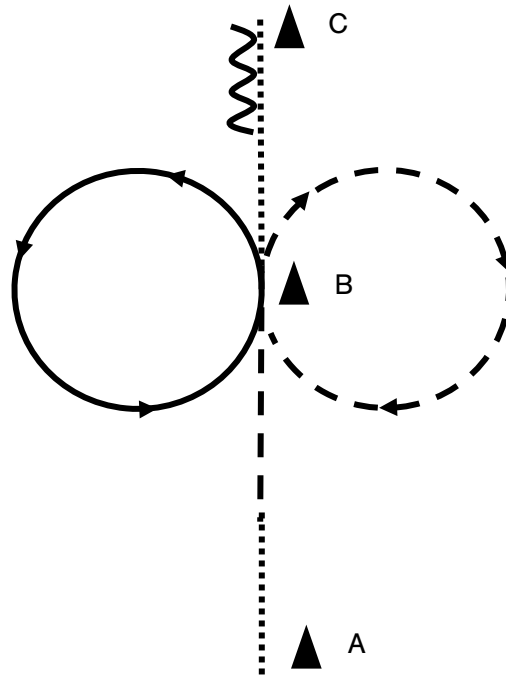

1. Be ready at cone A.
2. Walk halfway to cone B then pick up a sitting trot.
3. At B, posting correct diagonal circle to the right around B.
4. At B, left lead, circle to the left.
5. Walk B to C.
6. Halt at C.
7. At C back on horse length and exit at a trot.
8. Follow directions of ring steward.

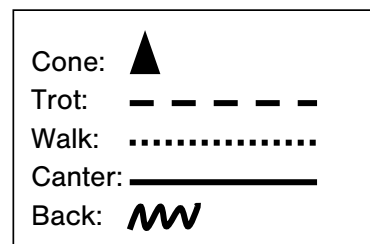



# Western Horsemanship Beginner Pattern

Produced by Horse Show Patterns.com

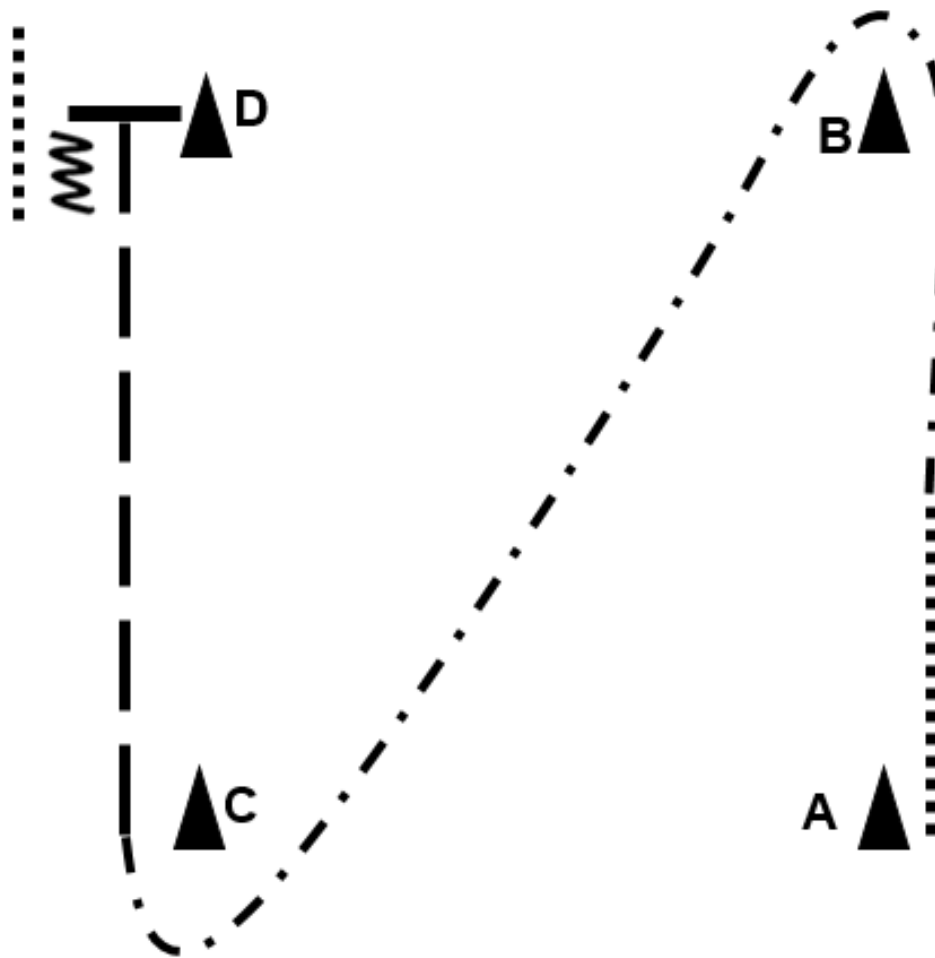

Be ready at cone A.

1. Walk halfway to cone B.
2. Jog to and around cone B.
3. Continue to jog to and around cone C.
4. Extend the jog from cone C to cone D.
5. Stop at cone D and back approximately one horse length.
6. Exit at a walk.

WALK .....  
JOG - . - . -  
EXTENDED JOG - - -  
BACK **MW**

# Western Horsemanship Junior Option 1

Pattern adapted from Montana State 4-H Horse Committee.

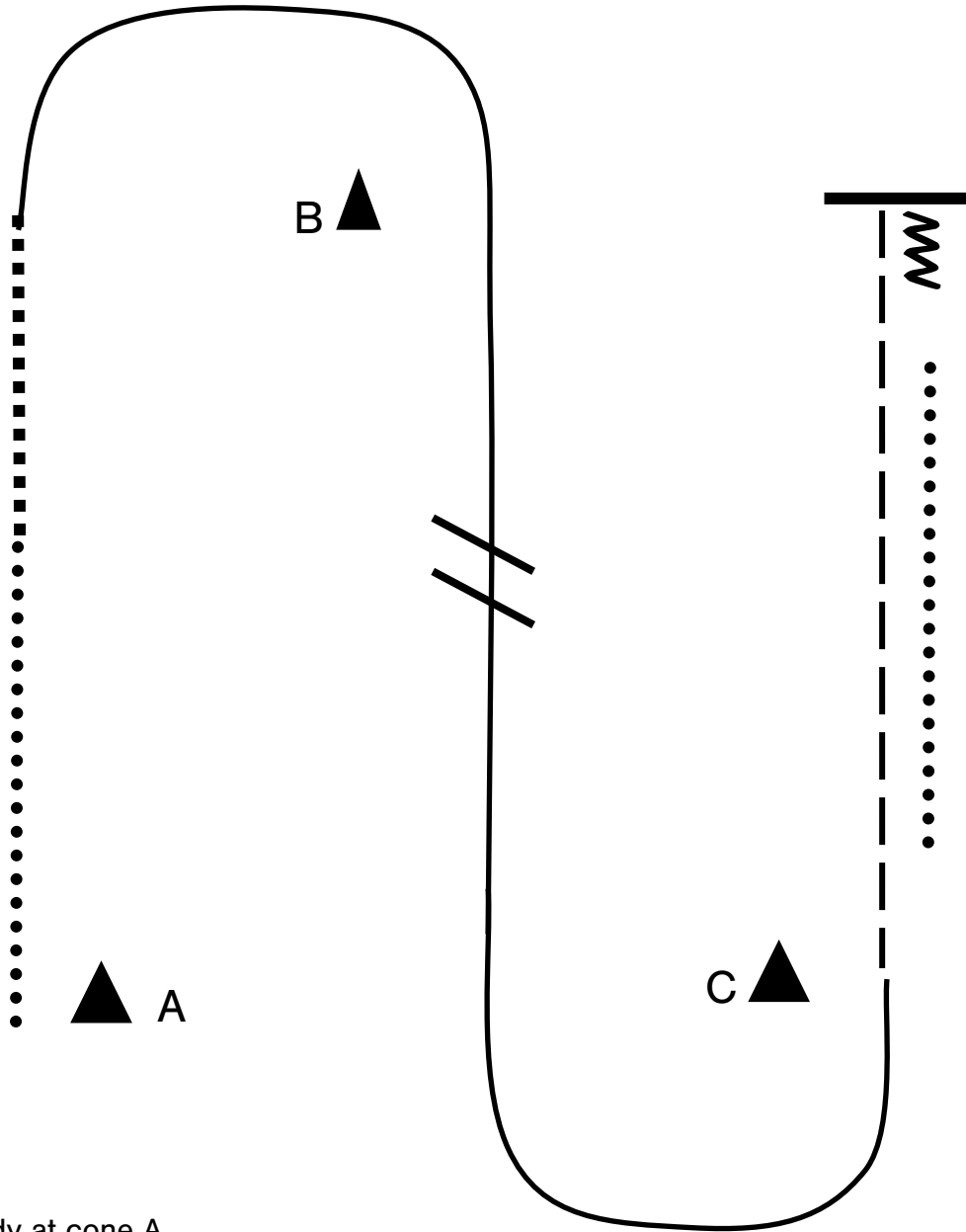

Be ready at cone A.

1. Walk from cone A to the center of pattern.
2. Jog until even with cone B.
3. Lope a half circle on the right lead to and around cone B.
4. Perform a lead change (simple or flying) in the center of the pattern.
5. Lope a half circle on the left lead until even with cone C.
6. Extended jog until even with cone B.
7. Stop and back approximately one horse length.
8. Perform a 180° turn on the hindquarters to the right and walk off.

|                     |       |
|---------------------|-------|
| <b>WALK</b>         | ••••• |
| <b>JOG</b>          | ▪▪▪▪▪ |
| <b>EXTENDED JOG</b> | — —   |
| <b>LOPE</b>         |       |
| <b>BACK</b>         | W     |
| <b>LEAD CHANGE</b>  | //    |

## Western Horsemanship Junior Pattern Option 2

Pattern adapted from HorseShowPattern.com

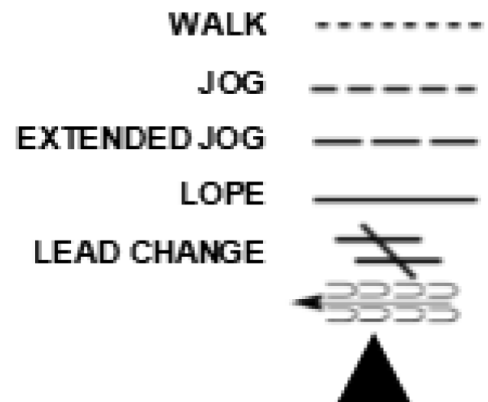
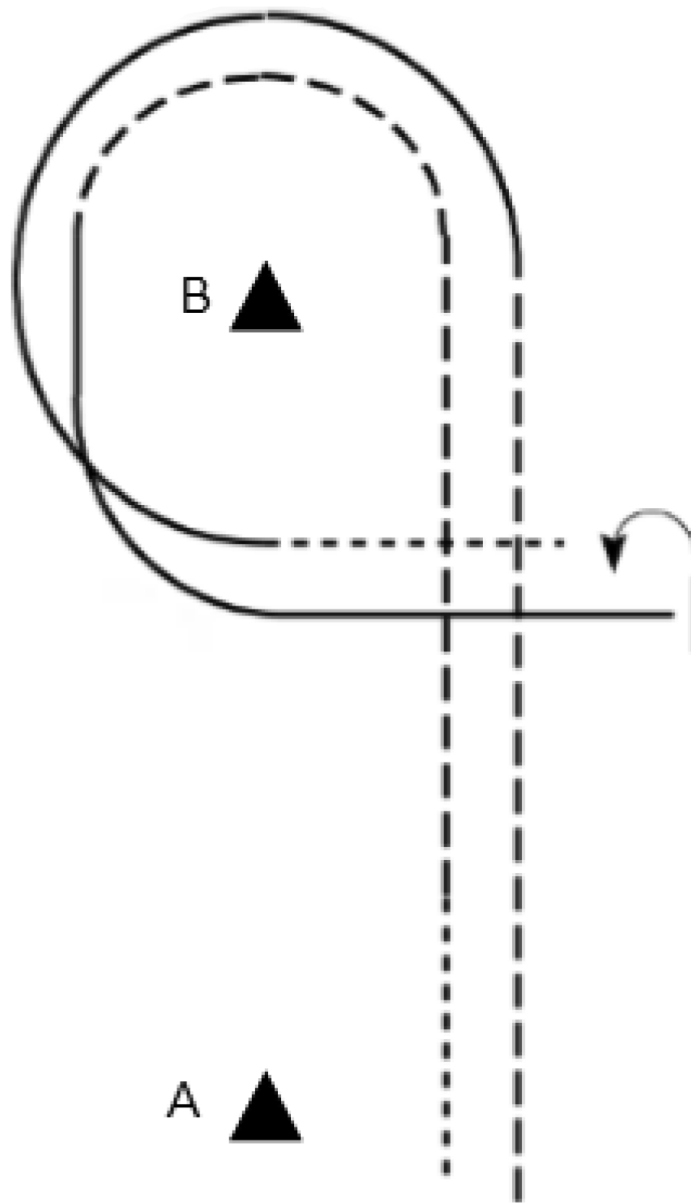

Be ready at cone A.

1. Walk approximately 2 horse lengths from cone A.
2. Jog to and around cone B.
3. Lope on the left lead to center of pattern and several horse lengths past the center line.
4. Stop and perform a 180° turn on the hindquarters to the left.
5. Walk to the center of the pattern.
6. Lope on the right lead to and around cone B.
7. Jog from cone B and past cone A.



## Reining Pattern Junior Option 1

Produced by *Horse Show Patterns.com*

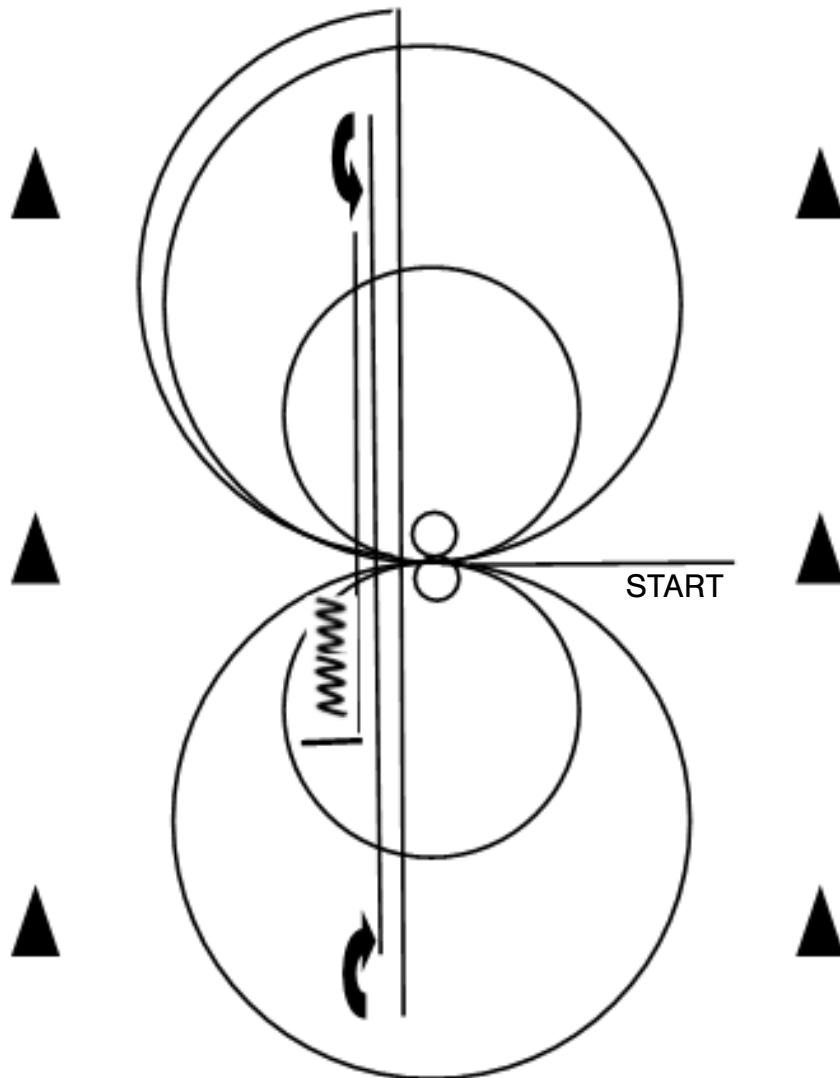

Begin at the center of the arena facing the left fence.

1. Perform one spin to right and one spin to left.
2. Lope two circles on the right lead: the first large and fast, the second small and slow.
3. Change leads in the center of the arena.
4. Lope two circles on the left lead: the first large and fast, the second small and slow.
5. Change leads in the center of the arena.
6. Continue around the previous large fast circle to the right. At the top of the circle, run down the middle to the far end of the arena, past the end marker stop and complete a right roll back - no hesitation.
7. Run to the opposite end of arena past the end marker, stop and preform a left rollback- no hesitation.
8. Run past the center marker and stop.
9. Back to center.

## Reining Pattern Junior Option 2

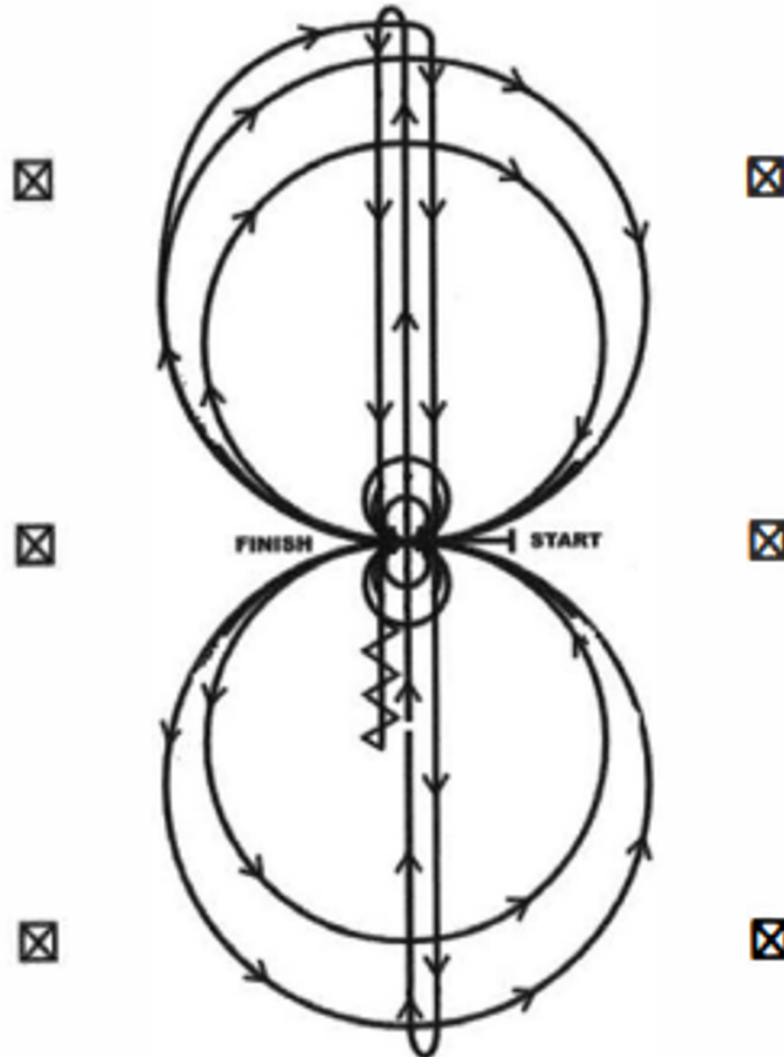

Horses may walk or jog to center of the arena. Horses must walk or stop prior to starting the pattern. Beginning at the center of the arena facing the left wall or fence.

1. Beginning on the right lead, complete two circles to the right: the first small and slow, the second large and fast. Change leads at the center of the arena.
2. Complete two circles to the left: the first circle small and slow, the second large and fast. Change leads at the center of the arena.
3. Continue around previous circle to the right. At the top of the circle, forward lope down the middle to the far end of the arena, past the end marker do a sliding stop and do a right rollback – no hesitation.
4. Forward lope up the middle to the opposite end of the arena past the end marker do a sliding stop and do a left rollback – no hesitation.
5. Forward lope past the center marker do a sliding stop. Back to the center of the arena or at least ten (10) feet. Hesitate.
6. Complete two spins to right. Hesitate.
7. Complete two spins to left. Hesitate to demonstrate completion of pattern.

# Ranch Riding Junior Pattern Option 1

Based on an AQHA® Ranch Riding pattern

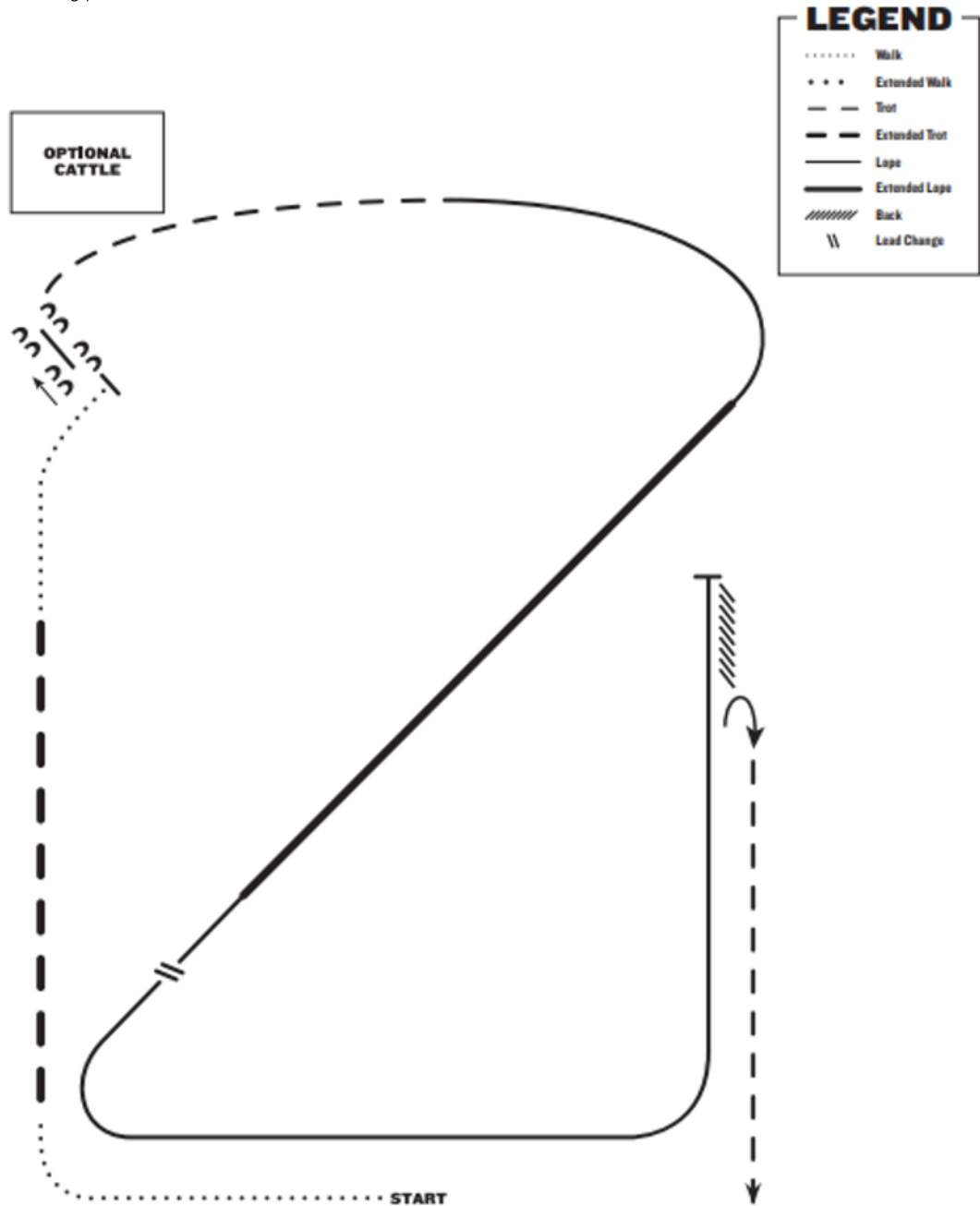

1. Walk
2. Extended trot
3. Walk
4. Stop, side pass left over log
5. Trot
6. Lope right lead
7. Extended lope right lead
8. Collect lope and change leads (simple or flying)
9. Lope left lead
10. Stope and back
11. 1/2 turn right
12. Trot

## Ranch Riding Junior Pattern Option 2

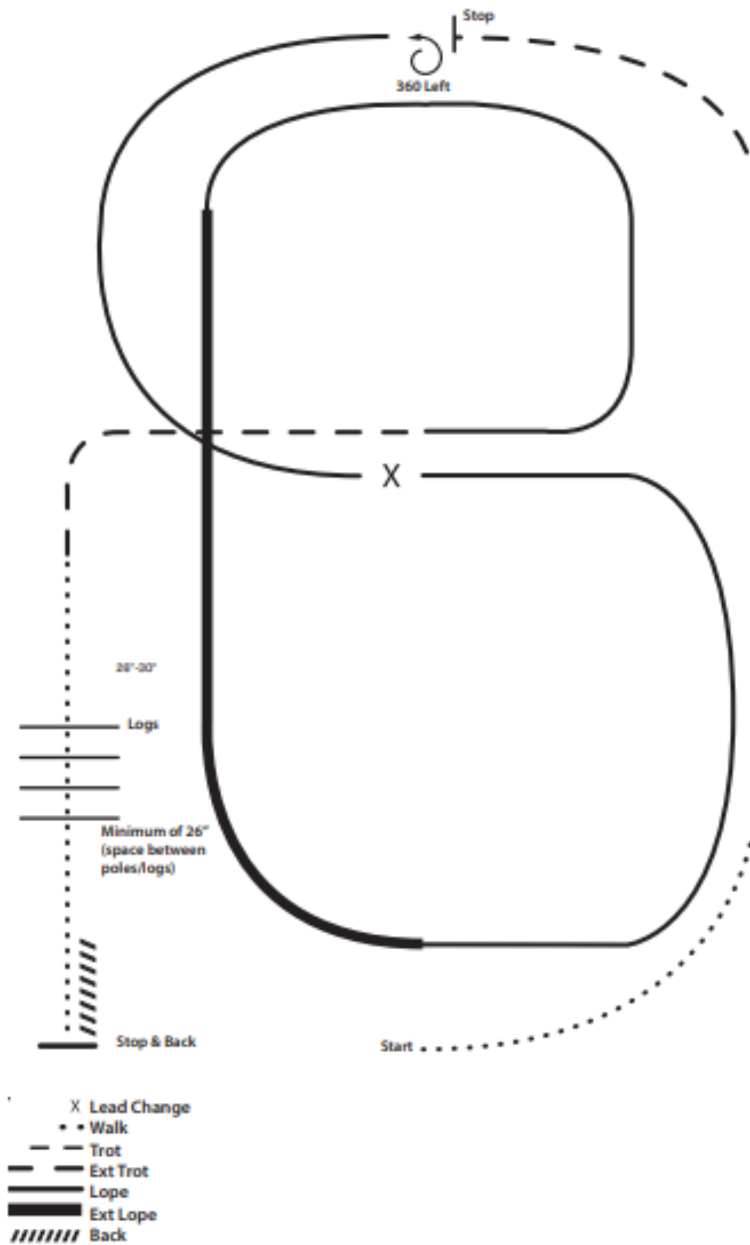

1. Walk.
2. Trot.
3. Extend the trot, at the top of the arena, stop.
4. 360-degree turn to the left.
5. Left lead  $\frac{1}{2}$  circle, lope to the center.
6. Change leads (simple or flying).
7. Right lead  $\frac{1}{2}$  circle.
8. Extended lope up the long side of the arena (right lead).
9. Collect back to the lope around the top of the arena and back to center.
10. Break down to an extended trot.
11. Walk over logs.
12. Stop and back.

## Beginner Trail Pattern

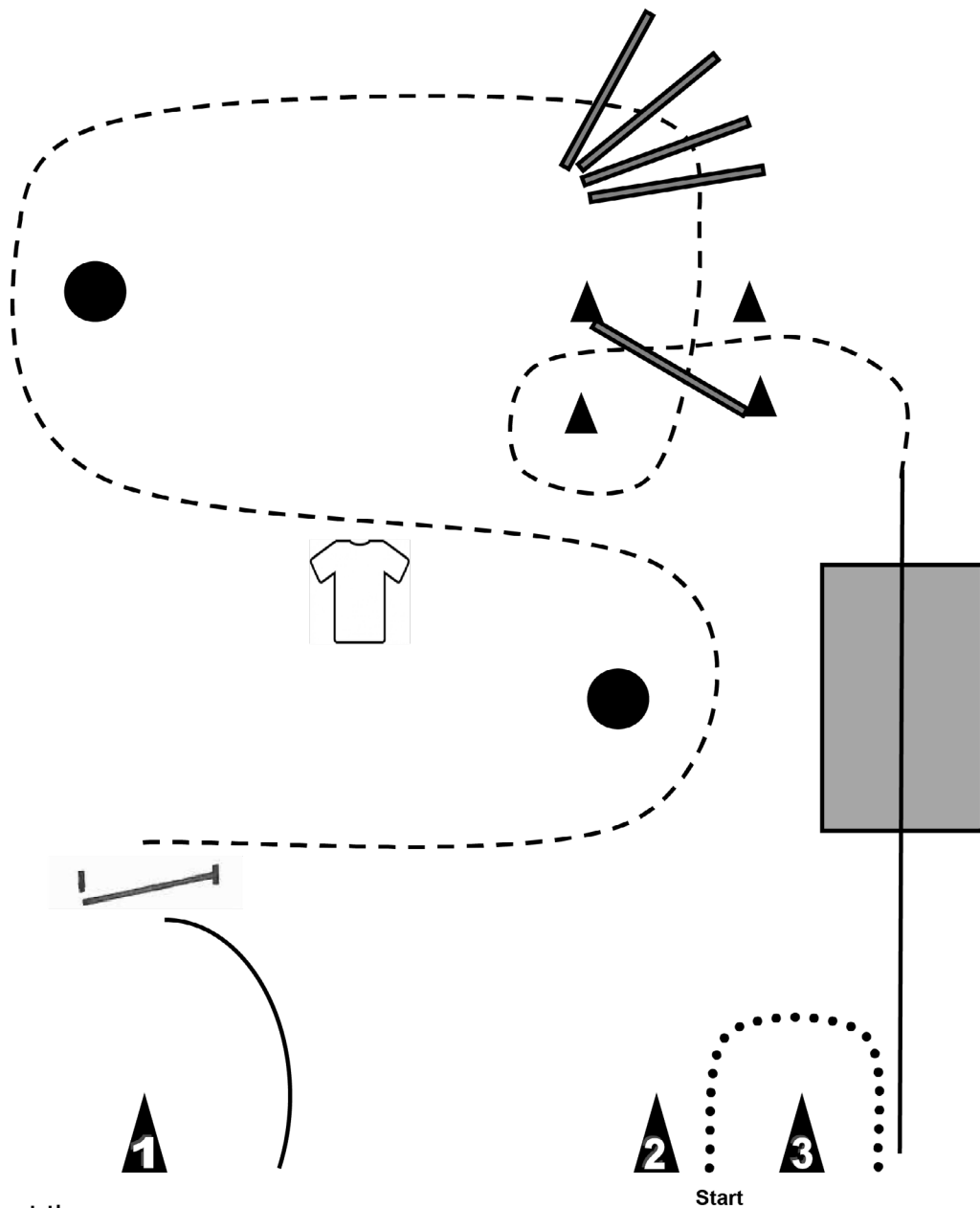

Be ready at the cone.

1. Back around Cone 3.
2. Walk over bridge.
3. Jog through cones, over log, around cone and over log again.
4. Continue jogging over four logs, left around Pole to slicker.
5. Stop, Sack out (rub) horse with slicker, hang back up.
6. Jog around pole and to gate
7. Stop, Walk through gate.
8. Exit at walk between cones 1 and 2.

Back .....  
 Walk ———  
 Jog - - - - -

## Junior Trail Pattern Option 1

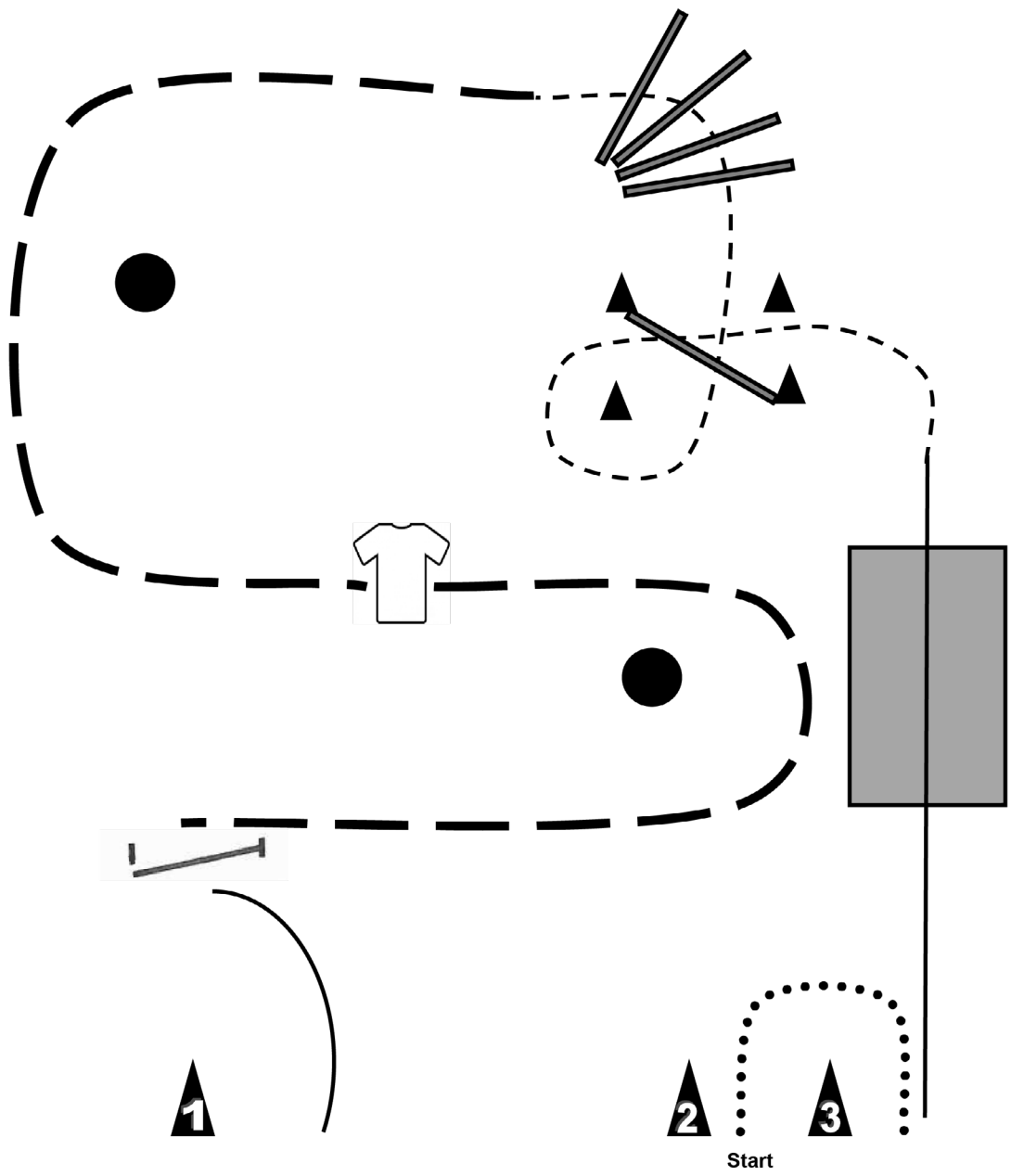

Be ready at the cone.

1. Back around Cone 3.
2. Walk over bridge.
3. Jog through cones, over log, around cone and over log again.  
Continue jogging over four logs.
4. Lope left lead around pole to slicker.
5. Stop, Sack out (rub) horse with slicker, hang back up.
6. Lope right lead around pole to gate.
7. Stop, perform a left handed push gate.
8. Exit at walk between cones 1 and 2.

- Back ..... (dotted line)
- Walk \_\_\_\_\_ (solid line)
- Jog - - - - - (dashed line)
- Lope - - - - - (thick dashed line)

## Junior Trail Option 2

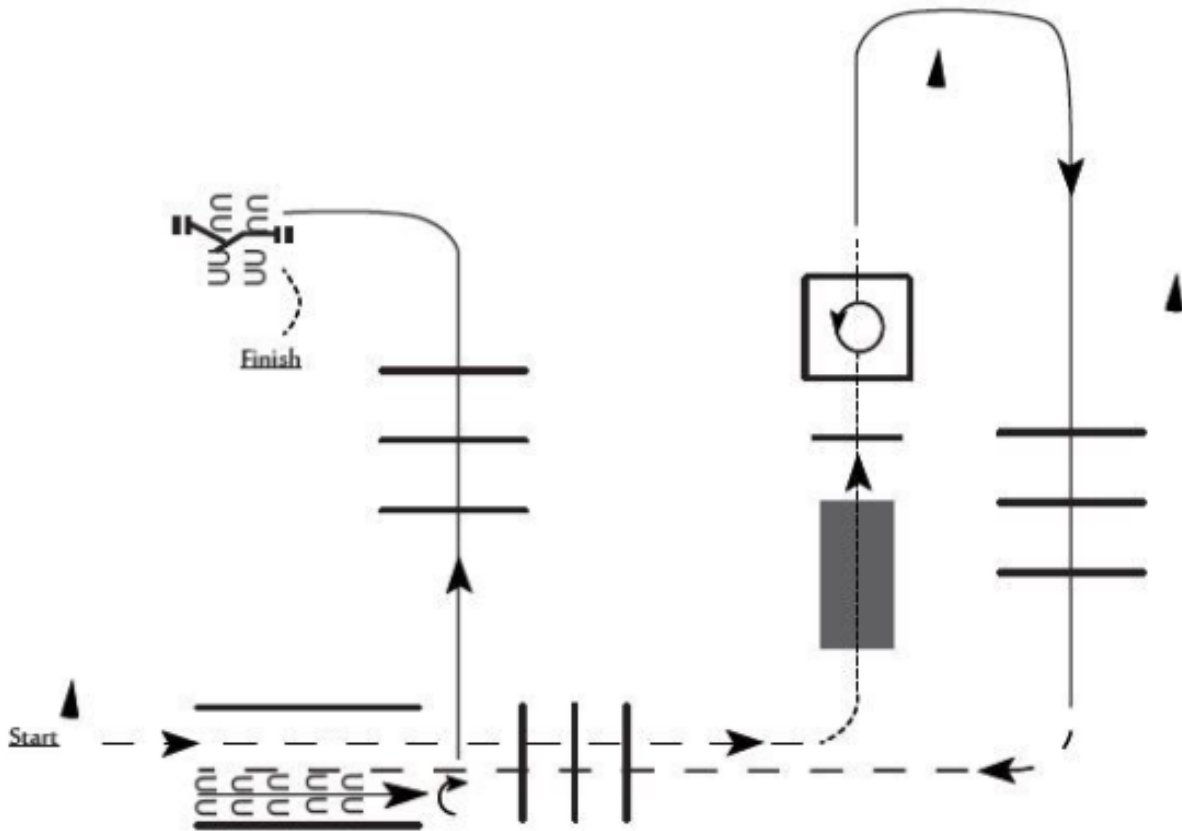

1. Jog through chute, over poles.
2. Walk to and over bridge. Walk into box.
3. Perform a full turn to the left and walk out.
4. Lope on the right lead around cone and over poles.
5. Jog over the logs and into the chute.
6. Stop and back out of chute. Perform a 1/4 turn to the right.
7. Lope on the left lead over poles and to gate.
8. Work the rope gate and walk to finish.

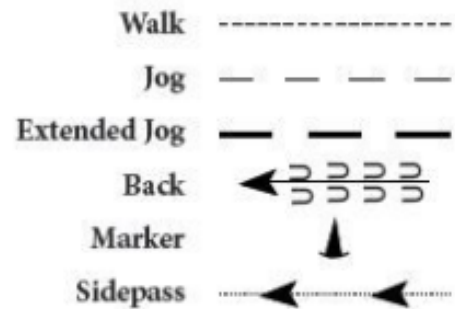

## Junior Reinsmanship Pattern 1

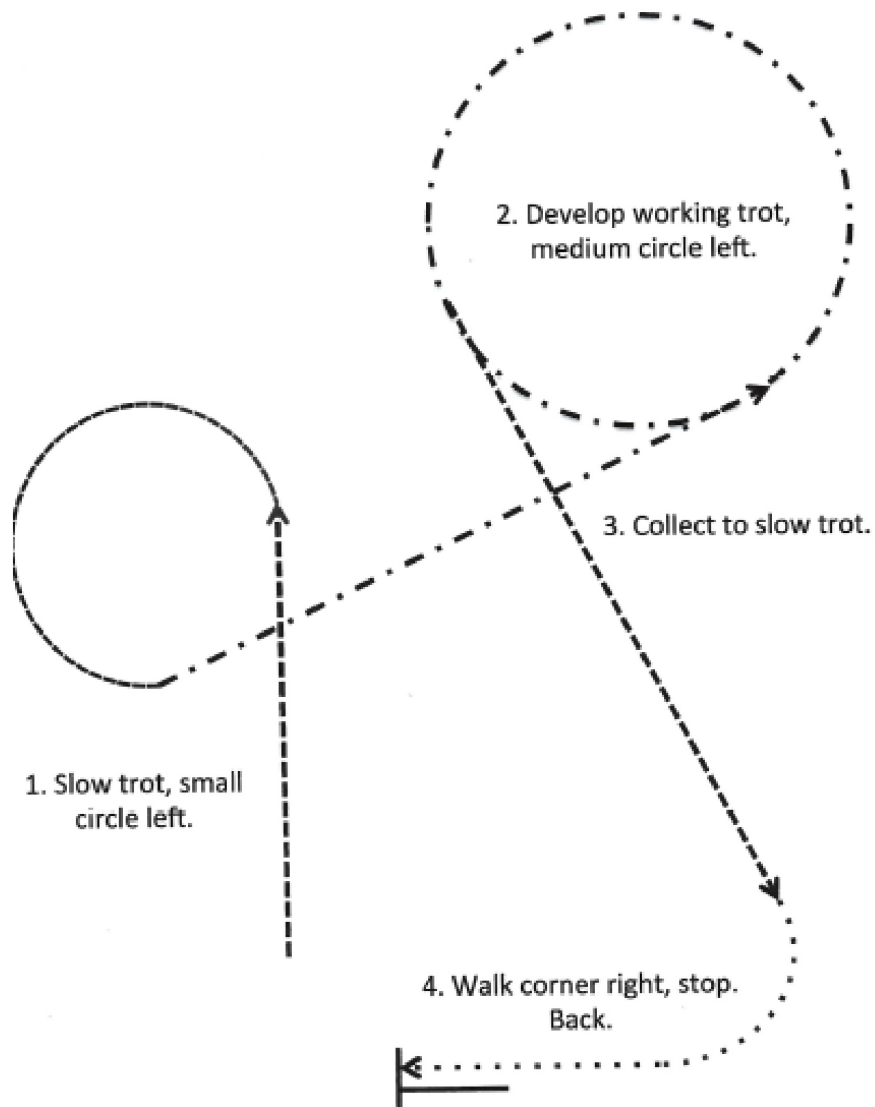

1. Slow trot, then perform a small circle to left.

2. Develop a working trot, then perform a medium circle to left

3. Collect to slow trot.

4. Break to walk, walk a corner to right.

5. Halt and back.

Walk .....

Slow trot - - - - -

Working trot - . - . .

Back \_\_\_\_\_





# Examples of Hunter over Fences Courses

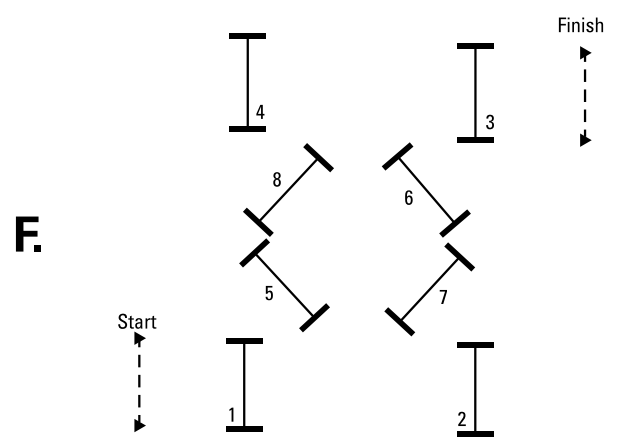
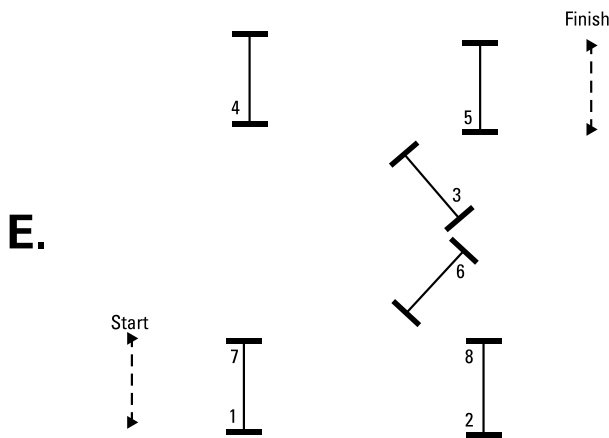
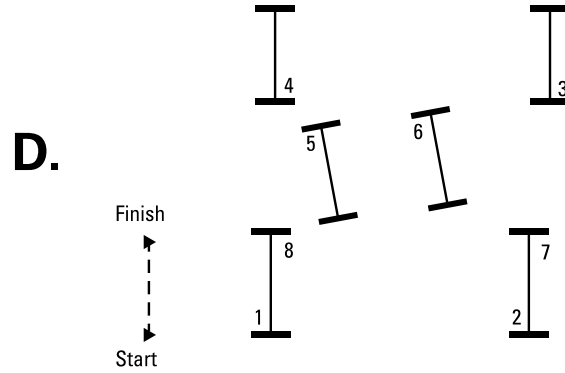
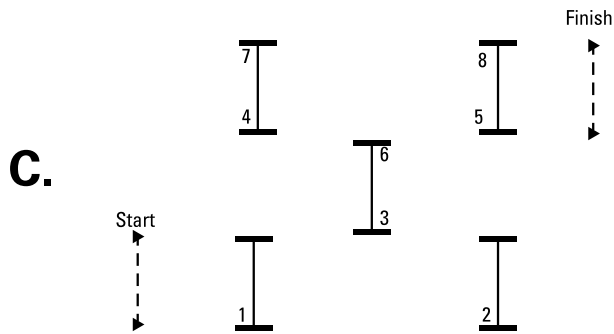
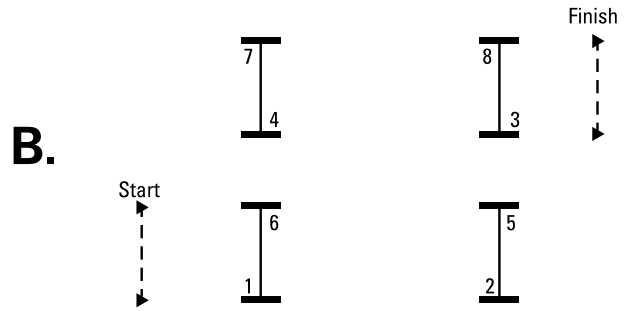
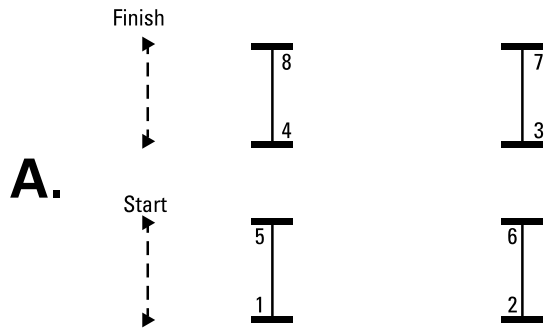

# **APPENDIX C**

## Score Sheets



Name \_\_\_\_\_ County \_\_\_\_\_ Beg. Jr. Sr.

Topic \_\_\_\_\_ Time \_\_\_\_\_

| CRITERIA  | Points Possible | Points Deducted | Comments |
|---|-----------------|-----------------|----------|
| <b>Introduction</b> <ul style="list-style-type: none"> <li>Did the introduction serve to create interest in the subject?</li> <li>Was introduction short and to the point?</li> </ul>   | 10              |                 |          |
| <b>Organization</b> <ul style="list-style-type: none"> <li>Were the main points easy to follow?</li> <li>Were the main points arranged in the best order?</li> <li>Were the sentences short, easy to understand?</li> <li>Was speech interesting?</li> </ul>  | 15              |                 |          |
| <b>Content &amp; Accuracy</b> <ul style="list-style-type: none"> <li>Were facts and information accurate?</li> <li>Was there enough information concerning the subject?</li> <li>Was credit given to sources of information, if appropriate?</li> <li>Was content appropriately related to the horse industry?</li> </ul>   | 20              |                 |          |
| <b>Stage Presence</b> <ul style="list-style-type: none"> <li>Was speaker neat and appropriately dressed?</li> <li>Was the speaker friendly?</li> <li>Did speaker talk directly to the audience?</li> <li>Did speaker look at the audience?</li> <li>Was posture erect, but not stiff?</li> <li>Did speaker refrain from leaning on podium?</li> <li>Did speaker seem relaxed and at ease?</li> </ul>                                      | 15              |                 |          |
| <b>Delivery</b> <ul style="list-style-type: none"> <li>Did speaker have appropriate voice control?</li> <li>Were all words pronounced correctly?</li> <li>Did speaker’s facial expressions reflect the mood of the speech?</li> <li>If notes were used, was it done without detracting from the speech?</li> <li>Did speaker seem to choose words at the time they were spoken?<br/>(Avoid a memorized or read-type delivery.)</li> </ul> | 20              |                 |          |
| <b>General</b> <ul style="list-style-type: none"> <li>Did speaker convey to the audience a sense of wanting to communicate?</li> <li>Did speech reflect the thoughts and personality of the speaker?</li> </ul>   | 10              |                 |          |
| <b>Conclusion</b> <ul style="list-style-type: none"> <li>Was the conclusion short and interesting?</li> <li>Did the conclusion properly wrap up the speech?</li> <li>Could the speaker handle questions easily?</li> </ul>  | 10              |                 |          |
| <b>TOTAL</b>  | <b>100</b>      |                 |          |

\_\_\_\_\_  
Judge’s Initials

**Circle Appropriate Ribbon Placing**

| Purple   | Blue    | Red     | White        |
|----------|---------|---------|--------------|
| (100-90) | (89-80) | (79-70) | (69 & below) |



**HORSE – Individual & Team  
Demonstration  
For State 4-H Horse Show Use ONLY**



Name \_\_\_\_\_ County \_\_\_\_\_ Beg. Jr. Sr.

Name \_\_\_\_\_ County \_\_\_\_\_ Beg. Jr. Sr.

Demonstration Title \_\_\_\_\_ Time \_\_\_\_\_

| CRITERIA   | Points Possible | Points Deducted | Comments |
|--|-----------------|-----------------|----------|
| <b>Introduction</b> <ul style="list-style-type: none"> <li>Did the introduction serve to create interest in the subject?</li> <li>Was introduction short and to the point?</li> <li>Was a catchy title used?</li> </ul>  | 10              |                 |          |
| <b>Organization</b> <ul style="list-style-type: none"> <li>Was only one main idea presented?</li> <li>Did the discussion relate directly to the step as it was shown?</li> <li>Was each step shown or illustrated just as it should be done in an actual situation?</li> <li>Could audience see each step?</li> <li>Were materials and equipment carefully selected, neatly arranged and well organized?</li> <li>Were key points of each step stressed?</li> </ul>  | 25              |                 |          |
| <b>Content &amp; Accuracy</b> <ul style="list-style-type: none"> <li>Were facts and information accurate?</li> <li>Was there enough information concerning the subject?</li> <li>Was credit given to sources of information, if appropriate?</li> <li>Was content appropriately related to the horse industry?</li> <li>Were approved practices used?</li> </ul>   | 25              |                 |          |
| <b>Stage Presence</b> <ul style="list-style-type: none"> <li>Was presenter neat and appropriately dressed for subject of presentation?</li> <li>Did speaker look at the audience?</li> <li>Did presenter speak directly to the audience?</li> <li>Was the presentation too fast or too slow?</li> <li>Was good teamwork displayed? (Team presentation generally not advisable for one person to do all the talking and the other one all the presenting.)</li> </ul> | 10              |                 |          |
| <b>Delivery</b> <ul style="list-style-type: none"> <li>Did the presenter appear to enjoy giving presentation?</li> <li>Did the presenter have good voice control?</li> <li>Were all words pronounced correctly?</li> <li>If notes were used, was it done without detracting from speech?</li> <li>Did speaker seem to choose words at the time they were spoken? (Avoid a memorized presentation.)</li> </ul>  | 15              |                 |          |
| <b>Effect on Audience</b> <ul style="list-style-type: none"> <li>Did audience show an interest in the presentation?</li> <li>Could audience go home and carry out the idea?</li> </ul>   | 5               |                 |          |
| <b>Summary</b> <ul style="list-style-type: none"> <li>Was the summary short and interesting?</li> <li>Were the key points briefly reviewed?</li> <li>Did the summary properly wrap up the presentation?</li> <li>Could presenter handle questions easily?</li> </ul>   | 10              |                 |          |
| <b>TOTAL</b>   | <b>100</b>      |                 |          |

\_\_\_\_\_  
Judge's Initials

**Circle Appropriate Ribbon Placing**

| Purple   | Blue    | Red     | White        |
|----------|---------|---------|--------------|
| (100-90) | (89-80) | (79-70) | (69 & below) |



# Horse Showmanship Class Score Sheet

Show: \_\_\_\_\_  
 Date: \_\_\_\_\_ Judge: \_\_\_\_\_  
 Class: \_\_\_\_\_

Maneuver Scores: Range from -3 to +3 (½ pint increments are acceptable) and are independent of penalty score. -3: Extremely Poor, -2: Very Poor, -1: Poor, 0: Correct, +1: Good, +2: Very Good, +3: Excellent

**Minor (3 point) Penalties:**

- Break of gait at walk or trot for up to two strides.
- Over or under turning up to ⅛ of a turn.
- Ticking or hitting a cone.
- Sliding a pivot foot.
- Lifting a pivot foot during a pivot or set-up replacing in same place.

**Major (5 point) Penalties:**

- Not performing gait or stopping within 10 feet of designated area.
- Break of gait at walk or trot for more than 2 strides.
- Splitting the cones (cone between horse and handler).
- Horse stepping out of or moving the hind end significantly during a pivot or turn.
- Horse stepping out of set-up after presentation
- Over/under turning ⅛ to ¼ turn

**Severe (10 point) Penalties:**

- Exhibitor is not in the required position during inspection\*
- Exhibitor is touching the horse\*
- Standing directly in front of horse.
- Loss of lead shank, holding chair or two hands on shank
- Severe disobedience

**Disqualifications: Will earn white ribbon**

- Loss of control that endangers exhibitors, others.
- Horse is separated from exhibitor
- Failure to wear number
- Willful abuse
- Never performing specific gait
- Excessive schooling
- Knocking over cone or going off pattern
- Illegal equipment
- Over or under turning by more than ¼ turn.

| ENTRY                |          | -3: Extremely Poor, -2: Very Poor, -1: Poor, 0: Correct, +1: Good, +2 Very Good, +3 Excellent |   |   |   |   |   |   |   |   |    | F&E | Total Penalty | Score | Comments |
|----------------------|----------|---|---|---|---|---|---|---|---|---|----|-----|---------------|-------|----------|
| Maneuver Description |          | 1   | 2 | 3 | 4 | 5 | 6 | 7 | 8 | 9 | 10 |     |               |       |          |
|                      | Penalty  |   |   |   |   |   |   |   |   |   |    |     |               |       |          |
|                      | Maneuver |   |   |   |   |   |   |   |   |   |    |     |               |       |          |
|                      | Penalty  |   |   |   |   |   |   |   |   |   |    |     |               |       |          |
|                      | Maneuver |   |   |   |   |   |   |   |   |   |    |     |               |       |          |
|                      | Penalty  |   |   |   |   |   |   |   |   |   |    |     |               |       |          |
|                      | Maneuver |   |   |   |   |   |   |   |   |   |    |     |               |       |          |
|                      | Penalty  |   |   |   |   |   |   |   |   |   |    |     |               |       |          |
|                      | Maneuver |   |   |   |   |   |   |   |   |   |    |     |               |       |          |
|                      | Penalty  |   |   |   |   |   |   |   |   |   |    |     |               |       |          |
|                      | Maneuver |   |   |   |   |   |   |   |   |   |    |     |               |       |          |
|                      | Penalty  |   |   |   |   |   |   |   |   |   |    |     |               |       |          |
|                      | Maneuver |   |   |   |   |   |   |   |   |   |    |     |               |       |          |
|                      | Penalty  |   |   |   |   |   |   |   |   |   |    |     |               |       |          |
|                      | Maneuver |   |   |   |   |   |   |   |   |   |    |     |               |       |          |

Judge's Signature: \_\_\_\_\_

# Horse Showmanship Class Score Sheet

| ENTRY                | -3: Extremely Poor, -2: Very Poor, -1: Poor, 0: Correct, +1: Good, +2 Very Good, +3 Excellent |   |   |   |   |   |   |   |   |    | F&E | Total Penalty | Score | Comments |  |
|----------------------|---|---|---|---|---|---|---|---|---|----|-----|---------------|-------|----------|--|
| Maneuver Description | 1   | 2 | 3 | 4 | 5 | 6 | 7 | 8 | 9 | 10 |     |               |       |          |  |
|                      | Penalty   |   |   |   |   |   |   |   |   |    |     |               |       |          |  |
|                      | Maneuver  |   |   |   |   |   |   |   |   |    |     |               |       |          |  |
|                      | Penalty   |   |   |   |   |   |   |   |   |    |     |               |       |          |  |
|                      | Maneuver  |   |   |   |   |   |   |   |   |    |     |               |       |          |  |
|                      | Penalty   |   |   |   |   |   |   |   |   |    |     |               |       |          |  |
|                      | Maneuver  |   |   |   |   |   |   |   |   |    |     |               |       |          |  |
|                      | Penalty   |   |   |   |   |   |   |   |   |    |     |               |       |          |  |
|                      | Maneuver  |   |   |   |   |   |   |   |   |    |     |               |       |          |  |
|                      | Penalty   |   |   |   |   |   |   |   |   |    |     |               |       |          |  |
|                      | Maneuver  |   |   |   |   |   |   |   |   |    |     |               |       |          |  |
|                      | Penalty   |   |   |   |   |   |   |   |   |    |     |               |       |          |  |
|                      | Maneuver  |   |   |   |   |   |   |   |   |    |     |               |       |          |  |
|                      | Penalty   |   |   |   |   |   |   |   |   |    |     |               |       |          |  |
|                      | Maneuver  |   |   |   |   |   |   |   |   |    |     |               |       |          |  |
|                      | Penalty   |   |   |   |   |   |   |   |   |    |     |               |       |          |  |
|                      | Maneuver  |   |   |   |   |   |   |   |   |    |     |               |       |          |  |
|                      | Penalty   |   |   |   |   |   |   |   |   |    |     |               |       |          |  |
|                      | Maneuver  |   |   |   |   |   |   |   |   |    |     |               |       |          |  |
|                      | Penalty   |   |   |   |   |   |   |   |   |    |     |               |       |          |  |
|                      | Maneuver  |   |   |   |   |   |   |   |   |    |     |               |       |          |  |

Judge's Signature: \_\_\_\_\_



**SOUTH DAKOTA STATE UNIVERSITY EXTENSION Horsemanship/Equitation Class Score Sheet**

Show: \_\_\_\_\_  
 Date: \_\_\_\_\_ Judge: \_\_\_\_\_  
 Class: \_\_\_\_\_

Maneuver Scores: Range from -3 to +3 (½ pint increments are acceptable) and are independent of penalty score. -3: Extremely Poor, -2: Very Poor, -1: Poor, 0: Correct, +1: Good, +2: Very Good, +3: Excellent

**Minor (3 point) Penalties:**

- Break of gait at walk or jog up to 2 strides
- Over/under turn from 1/8 to 1/4 turn
- Tick or hit of cone
- Obviously looking down to check leads

**Major (5 point) Penalties:**

- Not performing gait or stopping within 10 feet of designated area.
- Incorrect lead or break of gait (except when correcting an incorrect lead) at the lope
- Break of gait at walk, jog or trot for more than two strides.
- Loss of stirrup
- Head carried too low and/or clearly behind vertical while the horse is in motion; showing the appearance of intimidation.

**Severe (10 point) Penalties:**

- Loss of rein
- Use of either hand to instill fear/praise while on pattern.
- Holding saddle with either hand.
- Cueing with end of romal
- Blatant disobedience
- Spurring in front of cinch

**Disqualifications: Will earn white ribbon**

- Failure to display correct number.
- Abuse of horse or schooling
- Fall by horse or rider
- Illegal equipment or use of hands on reins
- Off pattern, including: knocking over cone, wrong side of cone, never performing designated gait or lead; over or under turning more than 1/4 turn.

| ENTRY                |          | -3: Extremely Poor, -2: Very Poor, -1: Poor, 0: Correct, +1: Good, +2 Very Good, +3 Excellent |   |   |   |   |   |   |   |   |    | F&E | Total Penalty | Score | Comments |
|----------------------|----------|---|---|---|---|---|---|---|---|---|----|-----|---------------|-------|----------|
| Maneuver Description |          | 1   | 2 | 3 | 4 | 5 | 6 | 7 | 8 | 9 | 10 |     |               |       |          |
|                      | Penalty  |   |   |   |   |   |   |   |   |   |    |     |               |       |          |
|                      | Maneuver |   |   |   |   |   |   |   |   |   |    |     |               |       |          |
|                      | Penalty  |   |   |   |   |   |   |   |   |   |    |     |               |       |          |
|                      | Maneuver |   |   |   |   |   |   |   |   |   |    |     |               |       |          |
|                      | Penalty  |   |   |   |   |   |   |   |   |   |    |     |               |       |          |
|                      | Maneuver |   |   |   |   |   |   |   |   |   |    |     |               |       |          |
|                      | Penalty  |   |   |   |   |   |   |   |   |   |    |     |               |       |          |
|                      | Maneuver |   |   |   |   |   |   |   |   |   |    |     |               |       |          |
|                      | Penalty  |   |   |   |   |   |   |   |   |   |    |     |               |       |          |
|                      | Maneuver |   |   |   |   |   |   |   |   |   |    |     |               |       |          |
|                      | Penalty  |   |   |   |   |   |   |   |   |   |    |     |               |       |          |
|                      | Maneuver |   |   |   |   |   |   |   |   |   |    |     |               |       |          |
|                      | Penalty  |   |   |   |   |   |   |   |   |   |    |     |               |       |          |
|                      | Maneuver |   |   |   |   |   |   |   |   |   |    |     |               |       |          |

Judge's Signature: \_\_\_\_\_



## Horsemanship/Equitation Class Score Sheet

| ENTRY                   |          | -3: Extremely Poor, -2: Very Poor, -1: Poor, 0: Correct, +1: Good, +2 Very Good, +3 Excellent |   |   |   |   |   |   |   |   |    | F&E | Total<br>Penalty | Score | Comments |
|-------------------------|----------|---|---|---|---|---|---|---|---|---|----|-----|------------------|-------|----------|
| Maneuver<br>Description |          | 1   | 2 | 3 | 4 | 5 | 6 | 7 | 8 | 9 | 10 |     |                  |       |          |
|                         | Penalty  |   |   |   |   |   |   |   |   |   |    |     |                  |       |          |
|                         | Maneuver |   |   |   |   |   |   |   |   |   |    |     |                  |       |          |
|                         | Penalty  |   |   |   |   |   |   |   |   |   |    |     |                  |       |          |
|                         | Maneuver |   |   |   |   |   |   |   |   |   |    |     |                  |       |          |
|                         | Penalty  |   |   |   |   |   |   |   |   |   |    |     |                  |       |          |
|                         | Maneuver |   |   |   |   |   |   |   |   |   |    |     |                  |       |          |
|                         | Penalty  |   |   |   |   |   |   |   |   |   |    |     |                  |       |          |
|                         | Maneuver |   |   |   |   |   |   |   |   |   |    |     |                  |       |          |
|                         | Penalty  |   |   |   |   |   |   |   |   |   |    |     |                  |       |          |
|                         | Maneuver |   |   |   |   |   |   |   |   |   |    |     |                  |       |          |
|                         | Penalty  |   |   |   |   |   |   |   |   |   |    |     |                  |       |          |
|                         | Maneuver |   |   |   |   |   |   |   |   |   |    |     |                  |       |          |
|                         | Penalty  |   |   |   |   |   |   |   |   |   |    |     |                  |       |          |
|                         | Maneuver |   |   |   |   |   |   |   |   |   |    |     |                  |       |          |
|                         | Penalty  |   |   |   |   |   |   |   |   |   |    |     |                  |       |          |
|                         | Maneuver |   |   |   |   |   |   |   |   |   |    |     |                  |       |          |
|                         | Penalty  |   |   |   |   |   |   |   |   |   |    |     |                  |       |          |
|                         | Maneuver |   |   |   |   |   |   |   |   |   |    |     |                  |       |          |
|                         | Penalty  |   |   |   |   |   |   |   |   |   |    |     |                  |       |          |
|                         | Maneuver |   |   |   |   |   |   |   |   |   |    |     |                  |       |          |
|                         | Penalty  |   |   |   |   |   |   |   |   |   |    |     |                  |       |          |
|                         | Maneuver |   |   |   |   |   |   |   |   |   |    |     |                  |       |          |
|                         | Penalty  |   |   |   |   |   |   |   |   |   |    |     |                  |       |          |
|                         | Maneuver |   |   |   |   |   |   |   |   |   |    |     |                  |       |          |
|                         | Penalty  |   |   |   |   |   |   |   |   |   |    |     |                  |       |          |
|                         | Maneuver |   |   |   |   |   |   |   |   |   |    |     |                  |       |          |

Judge's Signature: \_\_\_\_\_



# Reining Class Score Sheet

Show: \_\_\_\_\_  
 Date: \_\_\_\_\_ Judge: \_\_\_\_\_  
 Class: \_\_\_\_\_

**Scoring:** Scoring will be 0 to 100 with each horse/rider start with a 70. Performance of horse add or subtract maneuver scores and penalties.  
**Maneuver scores:** Range from -1 ½ to + 1 ½ and are independent of penalty score. +1 ½ Excellent, +1 Very Good, +½ Good, 0 Correct, -½ Poor, -1 Very Poor, -1 ½ Extremely Poor  
**Penalty ½:** Delay lead change for one stride; starting circles at job or exiting rollbacks at jog for up to two strides; over/under spinning up to ¼ of a turn  
**Penalty 1:** Out of lead (accumulative, one point for each quarter or circle or any part thereof), over/under spinning ¼ to ½ turn; missing center mark, not staying 20 feet off fence  
**Penalty 2:** Break of gait; freeze up in spin or rollback; on walk in patterns, cantering prior to reaching center of the arena and/or failure to stop or walk before executing a canter departure; on run in patterns, failure to be in cater prior to reaching first marker; failure to completely pass specified marker before initiating stop.  
**Penalty 5:** Spurring in front of cinch; use of hand to instill fear/praise; holding saddle horn; blatant disobedience.  
**0 or DQ:** More than index finger between reins; changing hands on reins; use of two hands (except in snaffle); failure to complete pattern as written (includes being out of lead more than 1 complete circle or around end of arena in run downs and backing more than 2 stride); jogging in excess of half circle or half-length of arena; over spins more than ¼ turn; fall to ground of horse or rider; dropping rein; failure to wear appropriate attire.

| Entry   | Exhb # | Maneuver Description | 1 | 2 | 3 | 4 | 5 | 6 | 7 | 8 | Total Penalty | Score |
|---------|--------|----------------------|---|---|---|---|---|---|---|---|---------------|-------|
|         |        |                      |   |   |   |   |   |   |   |   |               |       |
|         |        | Penalty              |   |   |   |   |   |   |   |   |               |       |
|         |        | Score                |   |   |   |   |   |   |   |   |               |       |
| Comment |        |                      |   |   |   |   |   |   |   |   |               |       |

| Entry   | Exhb # | Maneuver Description | 1 | 2 | 3 | 4 | 5 | 6 | 7 | 8 | Total Penalty | Score |
|---------|--------|----------------------|---|---|---|---|---|---|---|---|---------------|-------|
|         |        |                      |   |   |   |   |   |   |   |   |               |       |
|         |        | Penalty              |   |   |   |   |   |   |   |   |               |       |
|         |        | Score                |   |   |   |   |   |   |   |   |               |       |
| Comment |        |                      |   |   |   |   |   |   |   |   |               |       |

| Entry   | Exhb # | Maneuver Description | 1 | 2 | 3 | 4 | 5 | 6 | 7 | 8 | Total Penalty | Score |
|---------|--------|----------------------|---|---|---|---|---|---|---|---|---------------|-------|
|         |        |                      |   |   |   |   |   |   |   |   |               |       |
|         |        | Penalty              |   |   |   |   |   |   |   |   |               |       |
|         |        | Score                |   |   |   |   |   |   |   |   |               |       |
| Comment |        |                      |   |   |   |   |   |   |   |   |               |       |

| Entry   | Exhb # | Maneuver Description | 1 | 2 | 3 | 4 | 5 | 6 | 7 | 8 | Total Penalty | Score |
|---------|--------|----------------------|---|---|---|---|---|---|---|---|---------------|-------|
|         |        |                      |   |   |   |   |   |   |   |   |               |       |
|         |        | Penalty              |   |   |   |   |   |   |   |   |               |       |
|         |        | Score                |   |   |   |   |   |   |   |   |               |       |
| Comment |        |                      |   |   |   |   |   |   |   |   |               |       |

| Entry   | Exhb # | Maneuver Description | 1 | 2 | 3 | 4 | 5 | 6 | 7 | 8 | Total Penalty | Score |
|---------|--------|----------------------|---|---|---|---|---|---|---|---|---------------|-------|
|         |        |                      |   |   |   |   |   |   |   |   |               |       |
|         |        | Penalty              |   |   |   |   |   |   |   |   |               |       |
|         |        | Score                |   |   |   |   |   |   |   |   |               |       |
| Comment |        |                      |   |   |   |   |   |   |   |   |               |       |

Judge's Signature: \_\_\_\_\_

# Reining Class Score Sheet

| Entry          | Exhb # | Maneuver Description |   |   |   |   |   |   |   |   | Total Penalty | Score |
|----------------|--------|----------------------|---|---|---|---|---|---|---|---|---------------|-------|
|                |        |                      | 1 | 2 | 3 | 4 | 5 | 6 | 7 | 8 |               |       |
|                |        | Penalty              |   |   |   |   |   |   |   |   |               |       |
|                |        | Score                |   |   |   |   |   |   |   |   |               |       |
| <b>Comment</b> |        |                      |   |   |   |   |   |   |   |   |               |       |

| Entry          | Exhb # | Maneuver Description |   |   |   |   |   |   |   |   | Total Penalty | Score |
|----------------|--------|----------------------|---|---|---|---|---|---|---|---|---------------|-------|
|                |        |                      | 1 | 2 | 3 | 4 | 5 | 6 | 7 | 8 |               |       |
|                |        | Penalty              |   |   |   |   |   |   |   |   |               |       |
|                |        | Score                |   |   |   |   |   |   |   |   |               |       |
| <b>Comment</b> |        |                      |   |   |   |   |   |   |   |   |               |       |

| Entry          | Exhb # | Maneuver Description |   |   |   |   |   |   |   |   | Total Penalty | Score |
|----------------|--------|----------------------|---|---|---|---|---|---|---|---|---------------|-------|
|                |        |                      | 1 | 2 | 3 | 4 | 5 | 6 | 7 | 8 |               |       |
|                |        | Penalty              |   |   |   |   |   |   |   |   |               |       |
|                |        | Score                |   |   |   |   |   |   |   |   |               |       |
| <b>Comment</b> |        |                      |   |   |   |   |   |   |   |   |               |       |

| Entry          | Exhb # | Maneuver Description |   |   |   |   |   |   |   |   | Total Penalty | Score |
|----------------|--------|----------------------|---|---|---|---|---|---|---|---|---------------|-------|
|                |        |                      | 1 | 2 | 3 | 4 | 5 | 6 | 7 | 8 |               |       |
|                |        | Penalty              |   |   |   |   |   |   |   |   |               |       |
|                |        | Score                |   |   |   |   |   |   |   |   |               |       |
| <b>Comment</b> |        |                      |   |   |   |   |   |   |   |   |               |       |

| Entry          | Exhb # | Maneuver Description |   |   |   |   |   |   |   |   | Total Penalty | Score |
|----------------|--------|----------------------|---|---|---|---|---|---|---|---|---------------|-------|
|                |        |                      | 1 | 2 | 3 | 4 | 5 | 6 | 7 | 8 |               |       |
|                |        | Penalty              |   |   |   |   |   |   |   |   |               |       |
|                |        | Score                |   |   |   |   |   |   |   |   |               |       |
| <b>Comment</b> |        |                      |   |   |   |   |   |   |   |   |               |       |

| Entry          | Exhb # | Maneuver Description |   |   |   |   |   |   |   |   | Total Penalty | Score |
|----------------|--------|----------------------|---|---|---|---|---|---|---|---|---------------|-------|
|                |        |                      | 1 | 2 | 3 | 4 | 5 | 6 | 7 | 8 |               |       |
|                |        | Penalty              |   |   |   |   |   |   |   |   |               |       |
|                |        | Score                |   |   |   |   |   |   |   |   |               |       |
| <b>Comment</b> |        |                      |   |   |   |   |   |   |   |   |               |       |

| Entry          | Exhb # | Maneuver Description |   |   |   |   |   |   |   |   | Total Penalty | Score |
|----------------|--------|----------------------|---|---|---|---|---|---|---|---|---------------|-------|
|                |        |                      | 1 | 2 | 3 | 4 | 5 | 6 | 7 | 8 |               |       |
|                |        | Penalty              |   |   |   |   |   |   |   |   |               |       |
|                |        | Score                |   |   |   |   |   |   |   |   |               |       |
| <b>Comment</b> |        |                      |   |   |   |   |   |   |   |   |               |       |

| Entry          | Exhb # | Maneuver Description |   |   |   |   |   |   |   |   | Total Penalty | Score |
|----------------|--------|----------------------|---|---|---|---|---|---|---|---|---------------|-------|
|                |        |                      | 1 | 2 | 3 | 4 | 5 | 6 | 7 | 8 |               |       |
|                |        | Penalty              |   |   |   |   |   |   |   |   |               |       |
|                |        | Score                |   |   |   |   |   |   |   |   |               |       |
| <b>Comment</b> |        |                      |   |   |   |   |   |   |   |   |               |       |

Judge's Signature: \_\_\_\_\_

SDSU Extension is an equal opportunity provider and employer in accordance with the nondiscrimination policies of South Dakota State University, the South Dakota Board of Regents and the United States Department of Agriculture.

Learn more at [extension.sdstate.edu](http://extension.sdstate.edu).

© 2023, South Dakota Board of Regents



# Ranch Riding Score Sheet

Show: \_\_\_\_\_  
 Date: \_\_\_\_\_ Judge: \_\_\_\_\_  
 Class: \_\_\_\_\_

**Scoring:** Scoring will be 0 to 100 with each horse/rider start with a 70. Performance of horse add or subtract maneuver scores and penalties.  
**Maneuver scores:** Range from -1 ½ to + 1 ½ and are independent of penalty score. +1 ½ Excellent, +1 Very Good, +½ Good, 0 Correct, - ½ Poor, -1 Very Poor, -1 ½ Extremely Poor

**Penalty 1:** Too slow/per gait; over-bridled; out of frame; break of gait at walk or jog for 2 strides or less; split leg at lope

**Penalty 3:** Break of gait at walk or jog for more than 2 strides; break of gait at lope; wrong or out of lead; draped reins; out of lead or cross-cantering more than 2 strides when changing leads; trotting more than 3 strides when making a simple lead change; severe disturbance of any obstacle

**Penalty 5:** Blatant disobedience

**0 or DQ:** Illegal equipment; willful abuse; major disobedience or discipline

**Placed below horses performing all maneuvers:** Eliminate maneuver; incomplete maneuver

| Entry          | Exhb # | Maneuver Description |   |   |   |   |   |   |   |   | Total Penalty | Score |
|----------------|--------|----------------------|---|---|---|---|---|---|---|---|---------------|-------|
|                |        |                      | 1 | 2 | 3 | 4 | 5 | 6 | 7 | 8 |               |       |
|                |        | Penalty              |   |   |   |   |   |   |   |   |               |       |
|                |        | Score                |   |   |   |   |   |   |   |   |               |       |
| <b>Comment</b> |        |                      |   |   |   |   |   |   |   |   |               |       |

| Entry          | Exhb # | Maneuver Description |   |   |   |   |   |   |   |   | Total Penalty | Score |
|----------------|--------|----------------------|---|---|---|---|---|---|---|---|---------------|-------|
|                |        |                      | 1 | 2 | 3 | 4 | 5 | 6 | 7 | 8 |               |       |
|                |        | Penalty              |   |   |   |   |   |   |   |   |               |       |
|                |        | Score                |   |   |   |   |   |   |   |   |               |       |
| <b>Comment</b> |        |                      |   |   |   |   |   |   |   |   |               |       |

| Entry          | Exhb # | Maneuver Description |   |   |   |   |   |   |   |   | Total Penalty | Score |
|----------------|--------|----------------------|---|---|---|---|---|---|---|---|---------------|-------|
|                |        |                      | 1 | 2 | 3 | 4 | 5 | 6 | 7 | 8 |               |       |
|                |        | Penalty              |   |   |   |   |   |   |   |   |               |       |
|                |        | Score                |   |   |   |   |   |   |   |   |               |       |
| <b>Comment</b> |        |                      |   |   |   |   |   |   |   |   |               |       |

| Entry          | Exhb # | Maneuver Description |   |   |   |   |   |   |   |   | Total Penalty | Score |
|----------------|--------|----------------------|---|---|---|---|---|---|---|---|---------------|-------|
|                |        |                      | 1 | 2 | 3 | 4 | 5 | 6 | 7 | 8 |               |       |
|                |        | Penalty              |   |   |   |   |   |   |   |   |               |       |
|                |        | Score                |   |   |   |   |   |   |   |   |               |       |
| <b>Comment</b> |        |                      |   |   |   |   |   |   |   |   |               |       |

| Entry          | Exhb # | Maneuver Description |   |   |   |   |   |   |   |   | Total Penalty | Score |
|----------------|--------|----------------------|---|---|---|---|---|---|---|---|---------------|-------|
|                |        |                      | 1 | 2 | 3 | 4 | 5 | 6 | 7 | 8 |               |       |
|                |        | Penalty              |   |   |   |   |   |   |   |   |               |       |
|                |        | Score                |   |   |   |   |   |   |   |   |               |       |
| <b>Comment</b> |        |                      |   |   |   |   |   |   |   |   |               |       |

Judge's Signature: \_\_\_\_\_

# Ranch Riding Score Sheet

| Entry          | Exhb # | Maneuver Description |   |   |   |   |   |   |   |   | Total Penalty | Score |
|----------------|--------|----------------------|---|---|---|---|---|---|---|---|---------------|-------|
|                |        |                      | 1 | 2 | 3 | 4 | 5 | 6 | 7 | 8 |               |       |
|                |        | Penalty              |   |   |   |   |   |   |   |   |               |       |
|                |        | Score                |   |   |   |   |   |   |   |   |               |       |
| <b>Comment</b> |        |                      |   |   |   |   |   |   |   |   |               |       |

| Entry          | Exhb # | Maneuver Description |   |   |   |   |   |   |   |   | Total Penalty | Score |
|----------------|--------|----------------------|---|---|---|---|---|---|---|---|---------------|-------|
|                |        |                      | 1 | 2 | 3 | 4 | 5 | 6 | 7 | 8 |               |       |
|                |        | Penalty              |   |   |   |   |   |   |   |   |               |       |
|                |        | Score                |   |   |   |   |   |   |   |   |               |       |
| <b>Comment</b> |        |                      |   |   |   |   |   |   |   |   |               |       |

| Entry          | Exhb # | Maneuver Description |   |   |   |   |   |   |   |   | Total Penalty | Score |
|----------------|--------|----------------------|---|---|---|---|---|---|---|---|---------------|-------|
|                |        |                      | 1 | 2 | 3 | 4 | 5 | 6 | 7 | 8 |               |       |
|                |        | Penalty              |   |   |   |   |   |   |   |   |               |       |
|                |        | Score                |   |   |   |   |   |   |   |   |               |       |
| <b>Comment</b> |        |                      |   |   |   |   |   |   |   |   |               |       |

| Entry          | Exhb # | Maneuver Description |   |   |   |   |   |   |   |   | Total Penalty | Score |
|----------------|--------|----------------------|---|---|---|---|---|---|---|---|---------------|-------|
|                |        |                      | 1 | 2 | 3 | 4 | 5 | 6 | 7 | 8 |               |       |
|                |        | Penalty              |   |   |   |   |   |   |   |   |               |       |
|                |        | Score                |   |   |   |   |   |   |   |   |               |       |
| <b>Comment</b> |        |                      |   |   |   |   |   |   |   |   |               |       |

| Entry          | Exhb # | Maneuver Description |   |   |   |   |   |   |   |   | Total Penalty | Score |
|----------------|--------|----------------------|---|---|---|---|---|---|---|---|---------------|-------|
|                |        |                      | 1 | 2 | 3 | 4 | 5 | 6 | 7 | 8 |               |       |
|                |        | Penalty              |   |   |   |   |   |   |   |   |               |       |
|                |        | Score                |   |   |   |   |   |   |   |   |               |       |
| <b>Comment</b> |        |                      |   |   |   |   |   |   |   |   |               |       |

| Entry          | Exhb # | Maneuver Description |   |   |   |   |   |   |   |   | Total Penalty | Score |
|----------------|--------|----------------------|---|---|---|---|---|---|---|---|---------------|-------|
|                |        |                      | 1 | 2 | 3 | 4 | 5 | 6 | 7 | 8 |               |       |
|                |        | Penalty              |   |   |   |   |   |   |   |   |               |       |
|                |        | Score                |   |   |   |   |   |   |   |   |               |       |
| <b>Comment</b> |        |                      |   |   |   |   |   |   |   |   |               |       |

| Entry          | Exhb # | Maneuver Description |   |   |   |   |   |   |   |   | Total Penalty | Score |
|----------------|--------|----------------------|---|---|---|---|---|---|---|---|---------------|-------|
|                |        |                      | 1 | 2 | 3 | 4 | 5 | 6 | 7 | 8 |               |       |
|                |        | Penalty              |   |   |   |   |   |   |   |   |               |       |
|                |        | Score                |   |   |   |   |   |   |   |   |               |       |
| <b>Comment</b> |        |                      |   |   |   |   |   |   |   |   |               |       |

| Entry          | Exhb # | Maneuver Description |   |   |   |   |   |   |   |   | Total Penalty | Score |
|----------------|--------|----------------------|---|---|---|---|---|---|---|---|---------------|-------|
|                |        |                      | 1 | 2 | 3 | 4 | 5 | 6 | 7 | 8 |               |       |
|                |        | Penalty              |   |   |   |   |   |   |   |   |               |       |
|                |        | Score                |   |   |   |   |   |   |   |   |               |       |
| <b>Comment</b> |        |                      |   |   |   |   |   |   |   |   |               |       |

Judge's Signature: \_\_\_\_\_

SDSU Extension is an equal opportunity provider and employer in accordance with the nondiscrimination policies of South Dakota State University, the South Dakota Board of Regents and the United States Department of Agriculture.

Learn more at [extension.sdstate.edu](http://extension.sdstate.edu).

© 2023, South Dakota Board of Regents



# Reinsmanship Class Score Sheet

Show: \_\_\_\_\_  
 Date: \_\_\_\_\_ Judge: \_\_\_\_\_  
 Class: \_\_\_\_\_

Maneuver Scores: Range from -3 to +3 (½ pint increments are acceptable) and are independent of penalty score. -3: Extremely Poor, -2: Very Poor, -1: Poor, 0:Correct, +1: Good, +2: Very Good, +3: Excellent

**Disqualifications: Will earn white ribbon**

- Failure to display correct number.
- Abuse of horse or schooling
- Fall by horse or rider
- Illegal equipment or use of hands on reins
- Off pattern, including: knocking over cone, wrong side of cone, never performing designated gait

| ENTRY                |          | -3: Extremely Poor, -2: Very Poor, -1: Poor, 0: Correct, +1: Good, +2 Very Good, +3 Excellent |   |   |   |   |   |   |   |   |    | F&E | Total Penalty | Score | Comments |
|----------------------|----------|---|---|---|---|---|---|---|---|---|----|-----|---------------|-------|----------|
| Maneuver Description |          | 1   | 2 | 3 | 4 | 5 | 6 | 7 | 8 | 9 | 10 |     |               |       |          |
|                      | Penalty  |   |   |   |   |   |   |   |   |   |    |     |               |       |          |
|                      | Maneuver |   |   |   |   |   |   |   |   |   |    |     |               |       |          |
|                      | Penalty  |   |   |   |   |   |   |   |   |   |    |     |               |       |          |
|                      | Maneuver |   |   |   |   |   |   |   |   |   |    |     |               |       |          |
|                      | Penalty  |   |   |   |   |   |   |   |   |   |    |     |               |       |          |
|                      | Maneuver |   |   |   |   |   |   |   |   |   |    |     |               |       |          |
|                      | Penalty  |   |   |   |   |   |   |   |   |   |    |     |               |       |          |
|                      | Maneuver |   |   |   |   |   |   |   |   |   |    |     |               |       |          |
|                      | Penalty  |   |   |   |   |   |   |   |   |   |    |     |               |       |          |
|                      | Maneuver |   |   |   |   |   |   |   |   |   |    |     |               |       |          |
|                      | Penalty  |   |   |   |   |   |   |   |   |   |    |     |               |       |          |
|                      | Maneuver |   |   |   |   |   |   |   |   |   |    |     |               |       |          |
|                      | Penalty  |   |   |   |   |   |   |   |   |   |    |     |               |       |          |
|                      | Maneuver |   |   |   |   |   |   |   |   |   |    |     |               |       |          |
|                      | Penalty  |   |   |   |   |   |   |   |   |   |    |     |               |       |          |
|                      | Maneuver |   |   |   |   |   |   |   |   |   |    |     |               |       |          |

Judge's Signature: \_\_\_\_\_

# Reinsmanship Class Score Sheet

| ENTRY                   |          | -3: Extremely Poor, -2: Very Poor, -1: Poor, 0: Correct, +1: Good, +2 Very Good, +3 Excellent |   |   |   |   |   |   |   |   |    | F&E | Total<br>Penalty | Score | Comments |  |
|-------------------------|----------|---|---|---|---|---|---|---|---|---|----|-----|------------------|-------|----------|--|
| Maneuver<br>Description |          | 1   | 2 | 3 | 4 | 5 | 6 | 7 | 8 | 9 | 10 |     |                  |       |          |  |
|                         | Penalty  |   |   |   |   |   |   |   |   |   |    |     |                  |       |          |  |
|                         | Maneuver |   |   |   |   |   |   |   |   |   |    |     |                  |       |          |  |
|                         | Penalty  |   |   |   |   |   |   |   |   |   |    |     |                  |       |          |  |
|                         | Maneuver |   |   |   |   |   |   |   |   |   |    |     |                  |       |          |  |
|                         | Penalty  |   |   |   |   |   |   |   |   |   |    |     |                  |       |          |  |
|                         | Maneuver |   |   |   |   |   |   |   |   |   |    |     |                  |       |          |  |
|                         | Penalty  |   |   |   |   |   |   |   |   |   |    |     |                  |       |          |  |
|                         | Maneuver |   |   |   |   |   |   |   |   |   |    |     |                  |       |          |  |
|                         | Penalty  |   |   |   |   |   |   |   |   |   |    |     |                  |       |          |  |
|                         | Maneuver |   |   |   |   |   |   |   |   |   |    |     |                  |       |          |  |
|                         | Penalty  |   |   |   |   |   |   |   |   |   |    |     |                  |       |          |  |
|                         | Maneuver |   |   |   |   |   |   |   |   |   |    |     |                  |       |          |  |
|                         | Penalty  |   |   |   |   |   |   |   |   |   |    |     |                  |       |          |  |
|                         | Maneuver |   |   |   |   |   |   |   |   |   |    |     |                  |       |          |  |
|                         | Penalty  |   |   |   |   |   |   |   |   |   |    |     |                  |       |          |  |
|                         | Maneuver |   |   |   |   |   |   |   |   |   |    |     |                  |       |          |  |
|                         | Penalty  |   |   |   |   |   |   |   |   |   |    |     |                  |       |          |  |
|                         | Maneuver |   |   |   |   |   |   |   |   |   |    |     |                  |       |          |  |
|                         | Penalty  |   |   |   |   |   |   |   |   |   |    |     |                  |       |          |  |
|                         | Maneuver |   |   |   |   |   |   |   |   |   |    |     |                  |       |          |  |
|                         | Penalty  |   |   |   |   |   |   |   |   |   |    |     |                  |       |          |  |
|                         | Maneuver |   |   |   |   |   |   |   |   |   |    |     |                  |       |          |  |
|                         | Penalty  |   |   |   |   |   |   |   |   |   |    |     |                  |       |          |  |
|                         | Maneuver |   |   |   |   |   |   |   |   |   |    |     |                  |       |          |  |

Judge's Signature: \_\_\_\_\_



# Trail Class Score Sheet

Show: \_\_\_\_\_  
 Date: \_\_\_\_\_ Judge: \_\_\_\_\_  
 Class: \_\_\_\_\_

Maneuver Scores: Range from -1 ½ and +1 ½ and are independent of penalty score. -1 ½ Extremely poor, -1: Very Poor, -1/2: Poor, 0: Correct, +1/2: Good, +1: Very Good; +1 ½ Excellent

**½ Point Penalty**

- Each tick of log, pole, cone, or obstacle

**1 Point Penalty**

- Each hit of log, pole, cone, or obstacle
- Incorrect gait at walk or job for 2 strides or less
- Both front or hind feet in single-stride slot
- Skipping over or failing to step into required space
- Split pole in lope over
- Failure to meet correct strides, if specified

**3 Point Penalty**

- Break of gait at walk or job for more than 2 strides
- Out of lead or break of gait at lope (except correcting lead)
- Knocking down an elevated pole, cone, or severely disturbing obstacle
- Stepping outside of confines of, falling or jumping off or out of an obstacle with one foot.
- Missing or evading a pole that is part of a series of an obstacle with one foot.

**5 Point Penalty**

- Dropping slicker or object required to be carried
- First or second cumulative refusal
- Letting go of gate/dropping rope gate
- Use of hand to instill fear/praise
- Stepping outside confines or, falling or jumping off or out of an obstacle with more than one foot.
- Blatant disobedience
- Holding saddle with either hand
- Missing or evading a pole that is part of a series of an obstacle with more than one foot

**0 Score – White Ribbon**

- Two hands (except jr horse)
- More than 1 finger between split reins
- More than 3 refusals or no attempt at an obstacle
- Performing an obstacle incorrectly, or other than in specified order
- Failure to enter, exit or work an obstacle from correct side or direction
- Excessive schooling
- Failure to ever demonstrate gait or lead as designated

| ENTRY                |          | -3: Extremely Poor, -2: Very Poor, -1: Poor, 0: Correct, +1: Good, +2 Very Good, +3 Excellent |   |   |   |   |   |   |   |   |    | F&E | Total Penalty | Score | Comments |
|----------------------|----------|---|---|---|---|---|---|---|---|---|----|-----|---------------|-------|----------|
| Maneuver Description |          | 1   | 2 | 3 | 4 | 5 | 6 | 7 | 8 | 9 | 10 |     |               |       |          |
|                      | Penalty  |   |   |   |   |   |   |   |   |   |    |     |               |       |          |
|                      | Maneuver |   |   |   |   |   |   |   |   |   |    |     |               |       |          |
|                      | Penalty  |   |   |   |   |   |   |   |   |   |    |     |               |       |          |
|                      | Maneuver |   |   |   |   |   |   |   |   |   |    |     |               |       |          |
|                      | Penalty  |   |   |   |   |   |   |   |   |   |    |     |               |       |          |
|                      | Maneuver |   |   |   |   |   |   |   |   |   |    |     |               |       |          |
|                      | Penalty  |   |   |   |   |   |   |   |   |   |    |     |               |       |          |
|                      | Maneuver |   |   |   |   |   |   |   |   |   |    |     |               |       |          |
|                      | Penalty  |   |   |   |   |   |   |   |   |   |    |     |               |       |          |
|                      | Maneuver |   |   |   |   |   |   |   |   |   |    |     |               |       |          |
|                      | Penalty  |   |   |   |   |   |   |   |   |   |    |     |               |       |          |
|                      | Maneuver |   |   |   |   |   |   |   |   |   |    |     |               |       |          |
|                      | Penalty  |   |   |   |   |   |   |   |   |   |    |     |               |       |          |
|                      | Maneuver |   |   |   |   |   |   |   |   |   |    |     |               |       |          |

Judge's Signature: \_\_\_\_\_



## Trail Class Score Sheet

| ENTRY                |          | -3: Extremely Poor, -2: Very Poor, -1: Poor, 0: Correct, +1: Good, +2 Very Good, +3 Excellent |   |   |   |   |   |   |   |   |    | F&E | Total Penalty | Score | Comments |
|----------------------|----------|---|---|---|---|---|---|---|---|---|----|-----|---------------|-------|----------|
| Maneuver Description |          | 1   | 2 | 3 | 4 | 5 | 6 | 7 | 8 | 9 | 10 |     |               |       |          |
|                      | Penalty  |   |   |   |   |   |   |   |   |   |    |     |               |       |          |
|                      | Maneuver |   |   |   |   |   |   |   |   |   |    |     |               |       |          |
|                      | Penalty  |   |   |   |   |   |   |   |   |   |    |     |               |       |          |
|                      | Maneuver |   |   |   |   |   |   |   |   |   |    |     |               |       |          |
|                      | Penalty  |   |   |   |   |   |   |   |   |   |    |     |               |       |          |
|                      | Maneuver |   |   |   |   |   |   |   |   |   |    |     |               |       |          |
|                      | Penalty  |   |   |   |   |   |   |   |   |   |    |     |               |       |          |
|                      | Maneuver |   |   |   |   |   |   |   |   |   |    |     |               |       |          |
|                      | Penalty  |   |   |   |   |   |   |   |   |   |    |     |               |       |          |
|                      | Maneuver |   |   |   |   |   |   |   |   |   |    |     |               |       |          |
|                      | Penalty  |   |   |   |   |   |   |   |   |   |    |     |               |       |          |
|                      | Maneuver |   |   |   |   |   |   |   |   |   |    |     |               |       |          |
|                      | Penalty  |   |   |   |   |   |   |   |   |   |    |     |               |       |          |
|                      | Maneuver |   |   |   |   |   |   |   |   |   |    |     |               |       |          |
|                      | Penalty  |   |   |   |   |   |   |   |   |   |    |     |               |       |          |
|                      | Maneuver |   |   |   |   |   |   |   |   |   |    |     |               |       |          |
|                      | Penalty  |   |   |   |   |   |   |   |   |   |    |     |               |       |          |
|                      | Maneuver |   |   |   |   |   |   |   |   |   |    |     |               |       |          |
|                      | Penalty  |   |   |   |   |   |   |   |   |   |    |     |               |       |          |
|                      | Maneuver |   |   |   |   |   |   |   |   |   |    |     |               |       |          |
|                      | Penalty  |   |   |   |   |   |   |   |   |   |    |     |               |       |          |
|                      | Maneuver |   |   |   |   |   |   |   |   |   |    |     |               |       |          |
|                      | Penalty  |   |   |   |   |   |   |   |   |   |    |     |               |       |          |
|                      | Maneuver |   |   |   |   |   |   |   |   |   |    |     |               |       |          |

Judge's Signature: \_\_\_\_\_



# Over Fences Class Score Sheet

**Scoring:** Scoring will be 0 to 100 with each horse/rider start with a 70.

**Eliminations**

- Three accumulative refusals; Off Course; Rider or Horse falling

**Major Faults**

- A refusal; Loss of stirrup; trotting while on course when not part of course; loss of reins

Show: \_\_\_\_\_  
 Date: \_\_\_\_\_ Judge: \_\_\_\_\_  
 Class: \_\_\_\_\_

| Entry           | Exhb # | 1 | 2 | 3 | 4 | 5 | 6 | 7 | 8 | Way of going | Score |
|-----------------|--------|---|---|---|---|---|---|---|---|--------------|-------|
|                 |        |   |   |   |   |   |   |   |   |              |       |
| <b>Comments</b> |        |   |   |   |   |   |   |   |   |              |       |

| Entry           | Exhb # | 1 | 2 | 3 | 4 | 5 | 6 | 7 | 8 | Way of going | Score |
|-----------------|--------|---|---|---|---|---|---|---|---|--------------|-------|
|                 |        |   |   |   |   |   |   |   |   |              |       |
| <b>Comments</b> |        |   |   |   |   |   |   |   |   |              |       |

| Entry           | Exhb # | 1 | 2 | 3 | 4 | 5 | 6 | 7 | 8 | Way of going | Score |
|-----------------|--------|---|---|---|---|---|---|---|---|--------------|-------|
|                 |        |   |   |   |   |   |   |   |   |              |       |
| <b>Comments</b> |        |   |   |   |   |   |   |   |   |              |       |

| Entry           | Exhb # | 1 | 2 | 3 | 4 | 5 | 6 | 7 | 8 | Way of going | Score |
|-----------------|--------|---|---|---|---|---|---|---|---|--------------|-------|
|                 |        |   |   |   |   |   |   |   |   |              |       |
| <b>Comments</b> |        |   |   |   |   |   |   |   |   |              |       |

| Entry           | Exhb # | 1 | 2 | 3 | 4 | 5 | 6 | 7 | 8 | Way of going | Score |
|-----------------|--------|---|---|---|---|---|---|---|---|--------------|-------|
|                 |        |   |   |   |   |   |   |   |   |              |       |
| <b>Comments</b> |        |   |   |   |   |   |   |   |   |              |       |

| Entry           | Exhb # | 1 | 2 | 3 | 4 | 5 | 6 | 7 | 8 | Way of going | Score |
|-----------------|--------|---|---|---|---|---|---|---|---|--------------|-------|
|                 |        |   |   |   |   |   |   |   |   |              |       |
| <b>Comments</b> |        |   |   |   |   |   |   |   |   |              |       |

| Entry           | Exhb # | 1 | 2 | 3 | 4 | 5 | 6 | 7 | 8 | Way of going | Score |
|-----------------|--------|---|---|---|---|---|---|---|---|--------------|-------|
|                 |        |   |   |   |   |   |   |   |   |              |       |
| <b>Comments</b> |        |   |   |   |   |   |   |   |   |              |       |

Judge's Signature: \_\_\_\_\_